

# Determined

*A Science of Life without Free Will*



**Robert M. Sapolsky**

S U P P L E M E N T A L   R E S O U R C E S







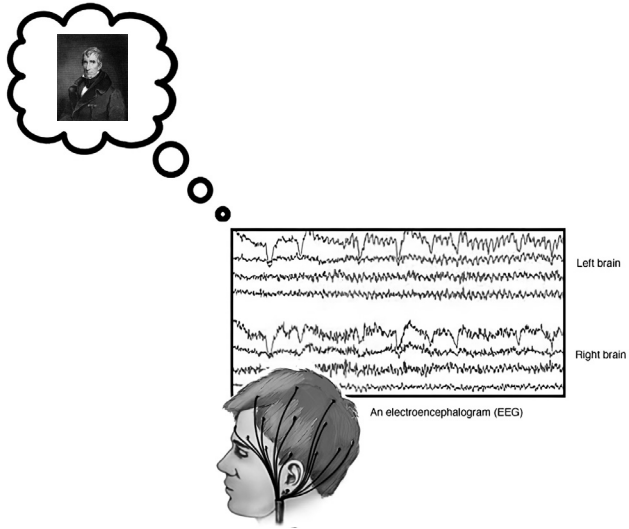



-

Copyright © 2023 by Robert M. Sapolsky

# EEG DIAGRAM



# ACE TABLE

ABUSE	NEGLECT	HOUSEHOLD DYSFUNCTION	
 Physical	 Physical	 Mental Illness	 Incarcerated Relative
 Emotional	 Emotional	 Mother treated violently	 Substance Abuse
 Sexual		 Divorce	

Source: Centers for Disease Control and Prevention

## RELATIVE AGE EFFECT CHART

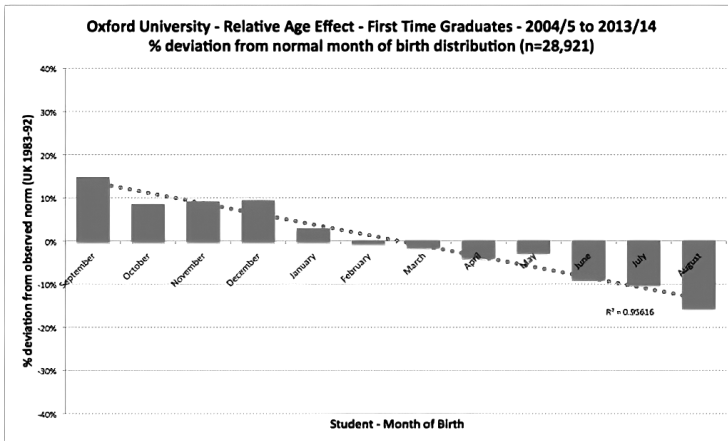

## WHAT YOU WERE GIVEN TABLE

“Biological stuff”	<i>Do you have grit?</i>
Having destructive sexual urges	<i>Do you resist acting upon them?</i>
Being a natural marathoner	<i>Do you fight through the pain?</i>
Not being all that bright	<i>Do you triumph by studying extra hard?</i>
Having a proclivity toward alcoholism	<i>Do you order ginger ale instead?</i>
Having a beautiful face	<i>Do you resist concluding that you're entitled to people being nice to you because of it?</i>

PRE- AND POSTLUNCH TRACINGS  
SUPERIMPOSED CHART

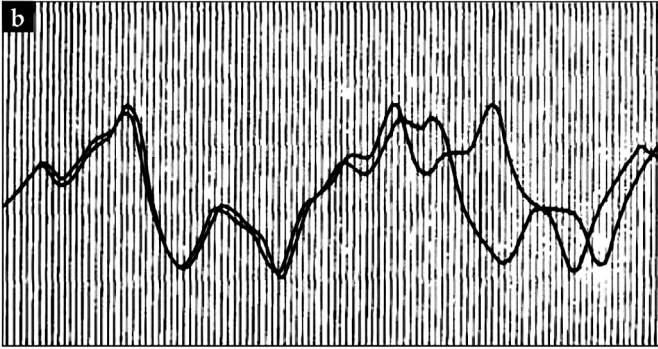

TIME

CHAOS THEORY TALK DOCUMENT

AMERICAN ASSOCIATION FOR THE ADVANCEMENT OF SCIENCE, 139th MEETING

Subject.....Predictability; Does the Flap of a Butterfly's wings in Brazil Set Off a Tornado in Texas?

Author.....Edward N. Lorenz, Sc.D.  
Professor of Meteorology

Address.....Massachusetts Institute of Technology  
Cambridge, Mass. 02139

Time.....10:00 a.m., December 29, 1972

Place.....Sheraton Park Hotel, Wilmington Room

Program.....AAAS Section on Environmental Sciences  
New Approaches to Global Weather: GARP  
(The Global Atmospheric Research Program)

Convention Address.....Sheraton Park Hotel

RELEASE TIME  
10:00 a.m., December 29



## CHAOTICISM AND SENSITIVE DEPENDENCE EXERCISE

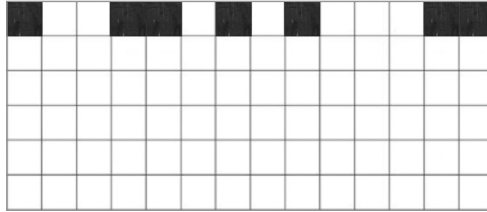

—

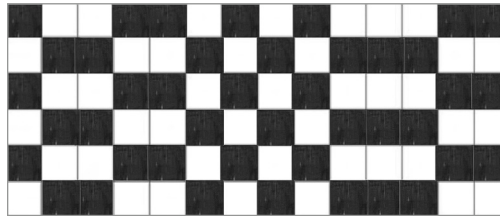

As the main point, starting with either of these rules, if you know the starting state (i.e., the pattern in row 1), you can accurately predict what a row anywhere in the future will look like. Our linear universe again.

Let's go back to our row 1:



Now whether a particular row 2 box will be open or filled is determined by the state of three boxes—the row 1 box immediately above and the row 1 box's neighbor on each side.

Here's a random rule for how the state of a trio of adjacent row 1 boxes determines what happens in the row 2 box below: *A row 2 box is filled if*

and only if one of the trio of boxes above it is filled in. Otherwise, the row 2 box will remain open.

Let's start with the second box from the left in row 2. Here is the row 1 trio immediately above it (i.e., the first three boxes of row 1):



One of three boxes is filled, meaning that the row 2 box we're considering will get filled:

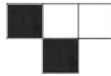

Look at the next trio in row 1 (i.e., boxes 2, 3, and 4). Only one box is filled, so box 3 in row 2 will also be filled:



In the row 1 trio of boxes 3, 4, and 5, two boxes (4 and 5) are filled, so the next row 2 box is left open. And so on. The rule we are working with—if and only if one box of the trio is filled, fill in the row 2 box in question—can be summarized like this:

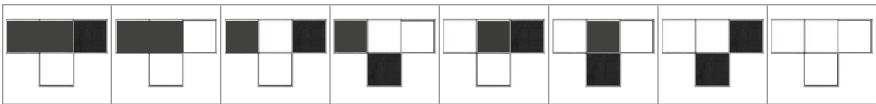

There are eight possible trios (two possible states for the first box of a trio times two possible for the second box times two for the third), and only trios 4, 6, and 7 result in the row 2 box in question being filled.

Back to our starting state, and using this rule, the first two rows will look like this:



But wait—what about the first and last boxes of row 2, where the box above has only one neighbor? We wouldn't have that problem if row 1 were infinitely long in both directions, but we don't have that luxury. What do we do with each of them? Just look at the box above it and the single neighbor, and use the same rule—if one of those two is filled, fill in the row 2 box; if both or neither of the two is filled, row 2 box is open. Thus, with that addendum in place, the first 2 rows look like this:

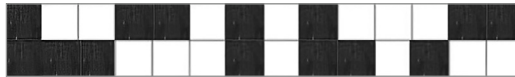

Now use the same rule to generate row 3:



Keep going, if you have nothing else to do.

Now let's use this starting state with the same rule:



The first 2 rows will look like this:



Complete the first 250 or so rows and you get this:

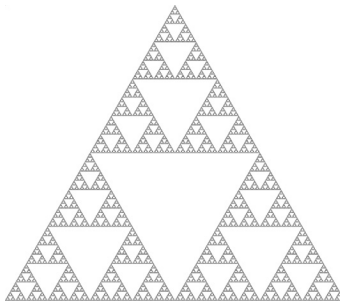

Take a different, wider random starting state, apply the same rule over and over, and you get this:

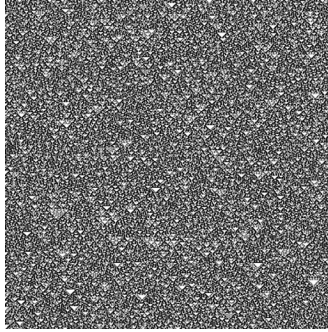

Whoa.

Now try this starting state:



By row 2, you get this:

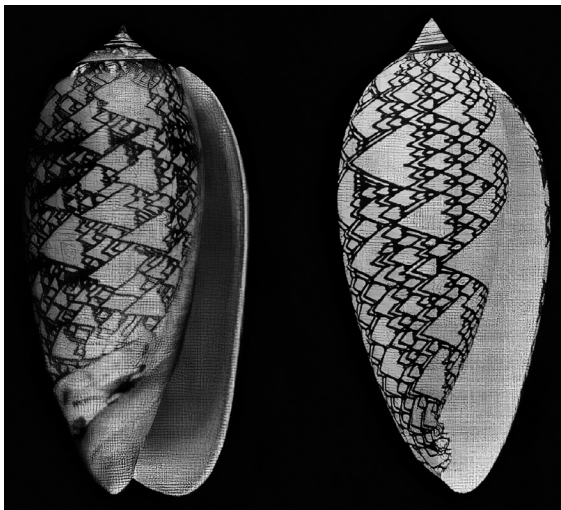

*An actual shell on the left, a computer-generated pattern on the right*

## RULE 22 EXERCISE

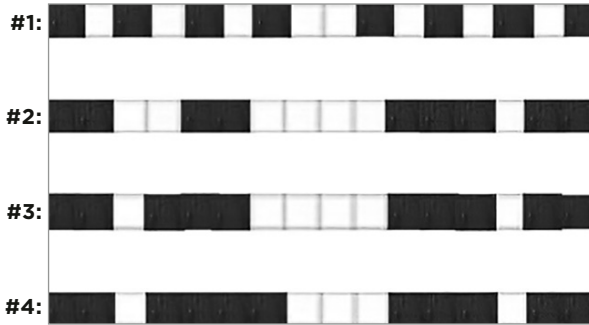

if it could have arisen from multiple different starting states, another defining feature of the chaoticism of this system.

Finally, consider the following starting state:



Which goes extinct by row 3:

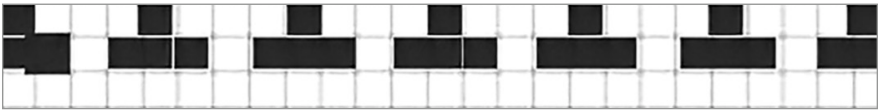

Introduce a smidgen of a difference in this nonviable starting state, namely that the open/filled status of just one of the twenty-five boxes differs—box 20 is filled instead of open:



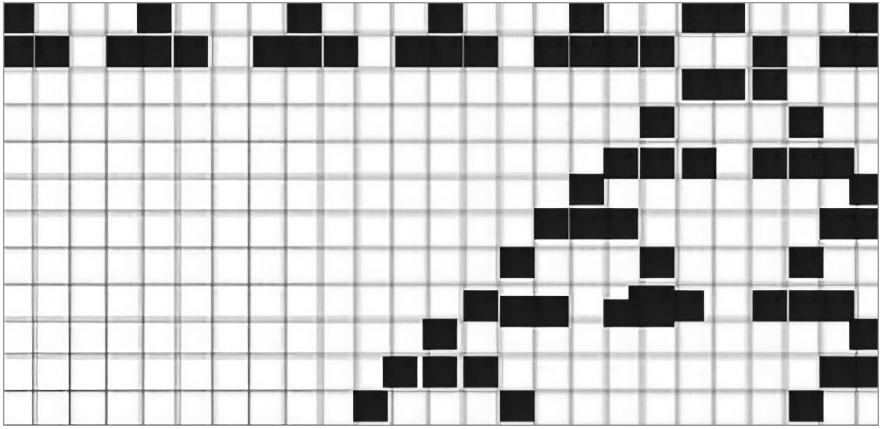

PICTURE

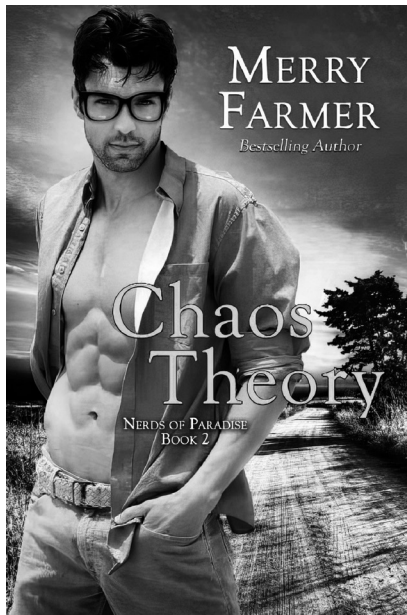

## MOLD PATHWAYS FIGURE

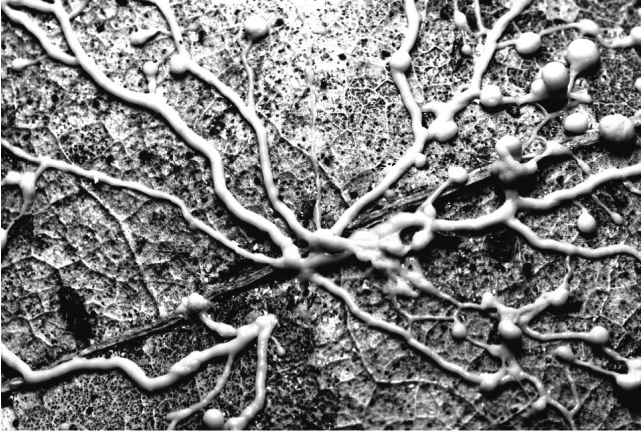

## MOLD PATHWAYS DIAGRAM

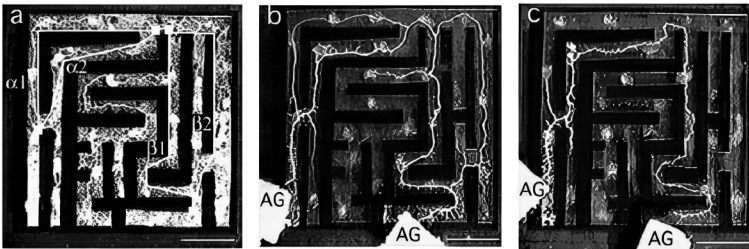

*Initially, the slime mold fills every path (panel a); it then begins retracting from superfluous paths (panel b), until eventually reaching the optimal solution (panel c). (Ignore the various markings.)*

TOKYO TRAVELING SLIME MOLD DIAGRAM

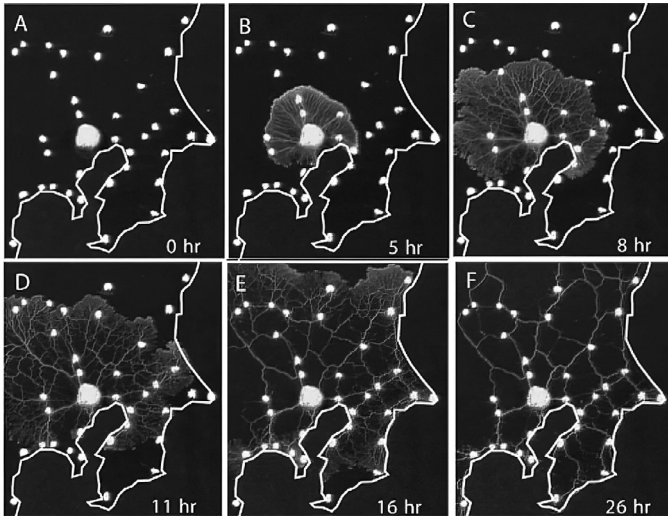

TYPES OF NEURONS IN  
CORTEX LAYERS FIGURE





## RADIAL GLIA FIGURE

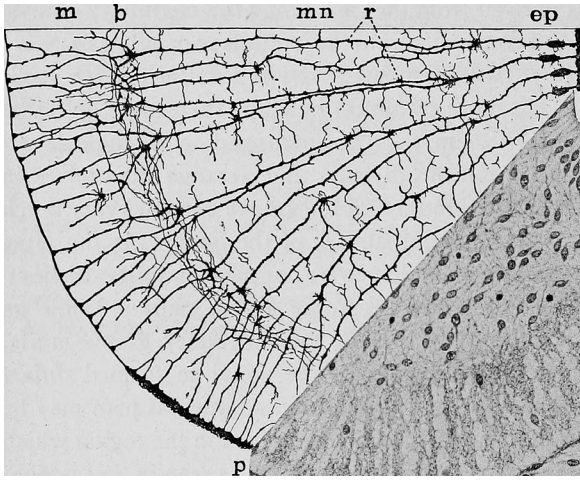

*Radial glia radiating outward from the center of a cross section*

## CANTON BAR FIGURE

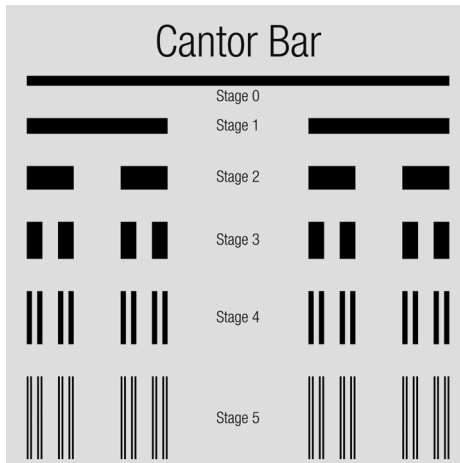

## KOCH SNOWFLAKE CONSTRUCTION DIAGRAM

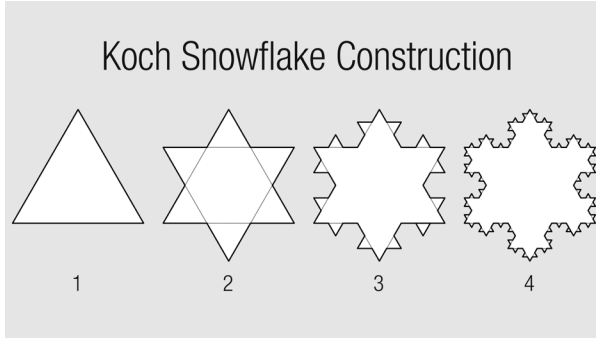

Now three dimensions. Take a cube. Each of its faces can be thought of as being a three-by-three grid of nine boxes. Take out the middle-most of those nine boxes, leaving eight:

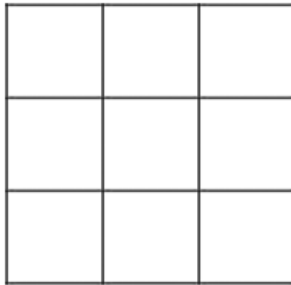

## MENGER SPONGE ILLUSTRATION

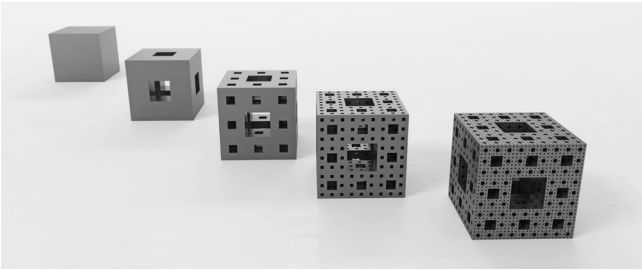

## BRANCHING PATTERNS IN CAPILLARY BEDS FIGURE



*Branching patterns in capillary beds*

# TEXTBOX DRAWING OF A NEURON

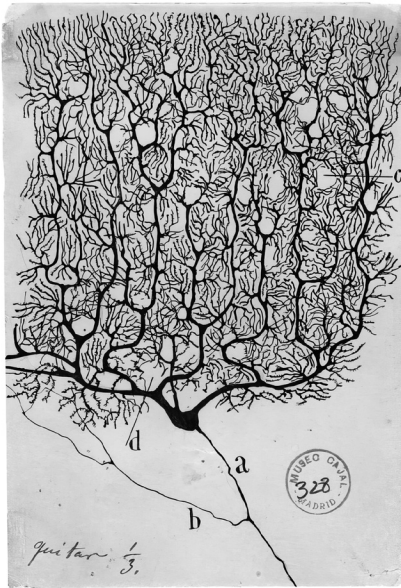

*A classic textbook drawing of an actual neuron*

# TUBE GROWING FIGURE

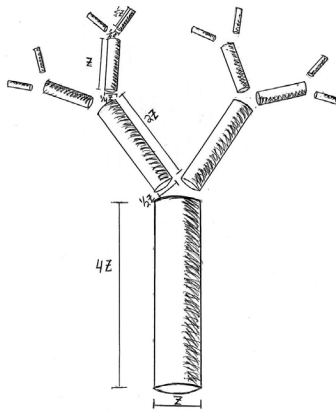

## NEURON GROWING FIGURE 1

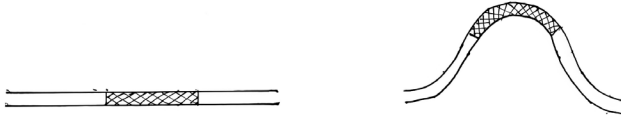

## NEURON GROWING FIGURE 2

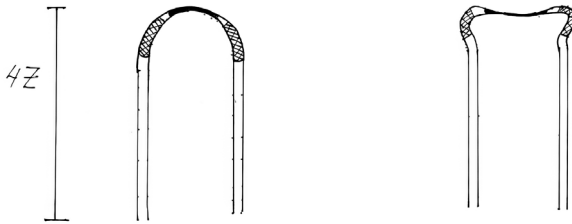

## NEURON GROWING FIGURE 3

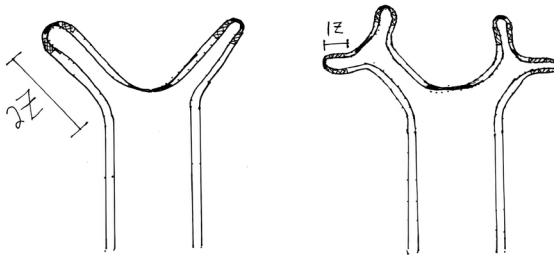

# WORLD RELIGIONS TREE

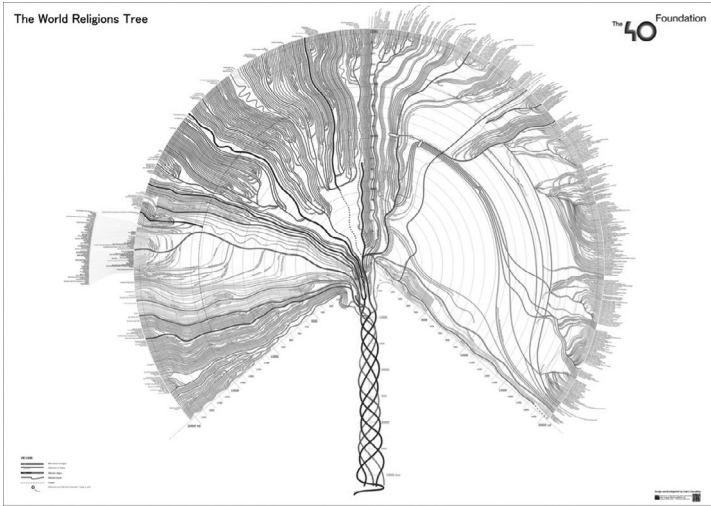

## HISTORY OF RELIGIOUS BRANCHING (PIECE)

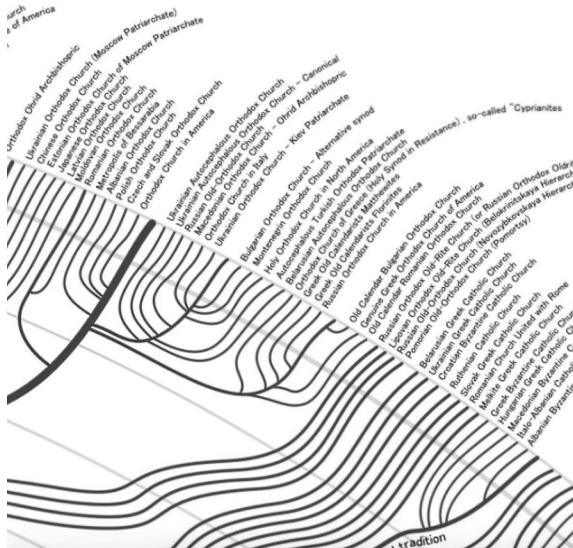

*One tiny piece of the history of religious branching*

## NEURONS GROWING FIGURE

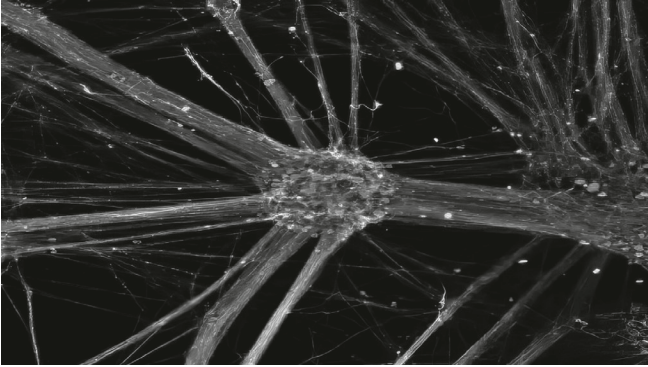

## 80:20 RULE DIAGRAMS

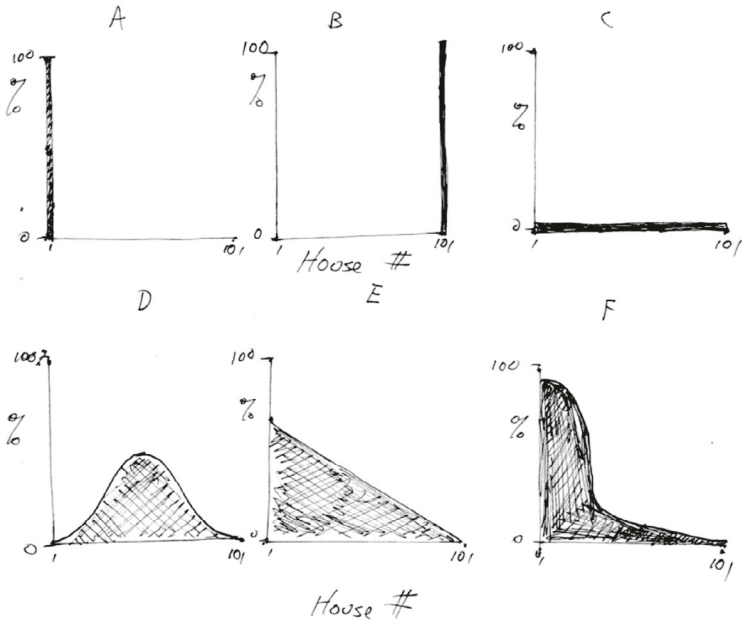

EXAMPLE OF EMERGENCE 1

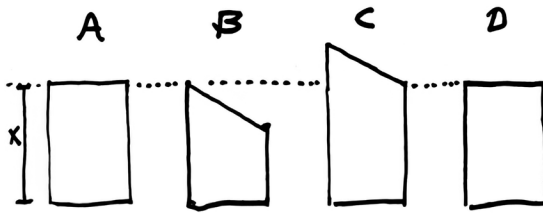

EXAMPLE OF EMERGENCE 2

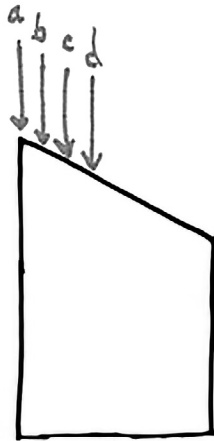



## ORGANOID NEURONS FIGURE

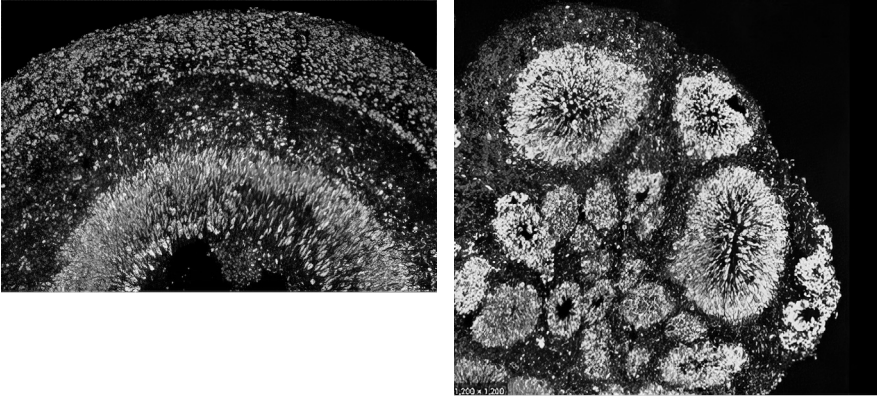

## EMERGENT INDETERMINISM DIAGRAM 1

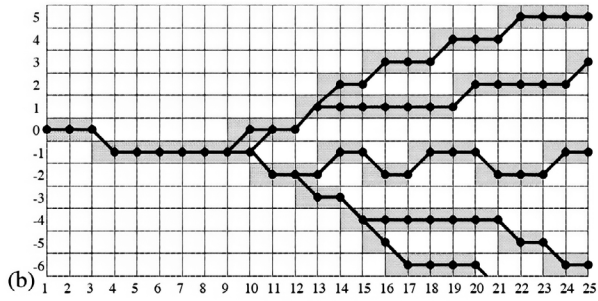
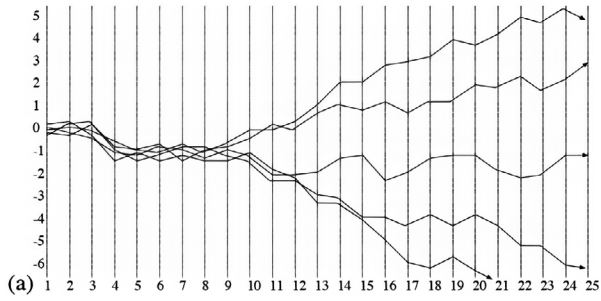

Emergent indeterminism

## EMERGENT INDETERMINISM DIAGRAM 2

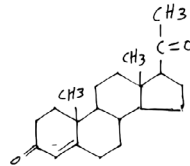
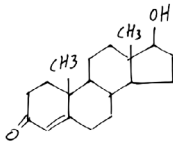
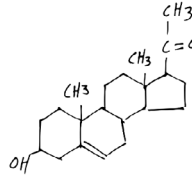
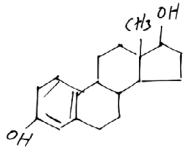
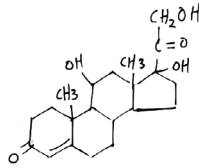
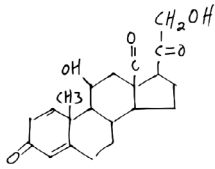

## FREE WILL CURVE

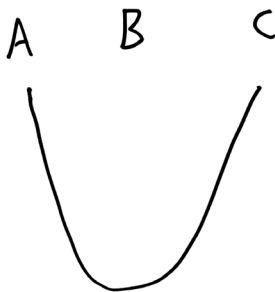

APLYSIA CALIFORNICA FIGURE

**A Gill Withdrawal Reflex**

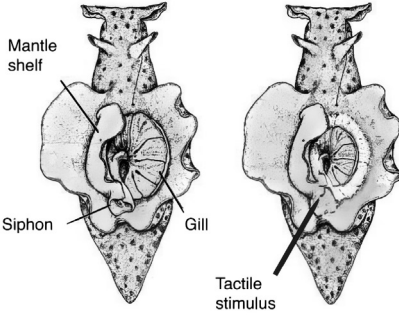

**B Sensitization**

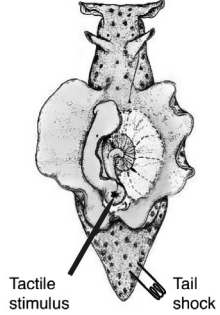

APLYSIA SN-MN CONNECTION DIAGRAM

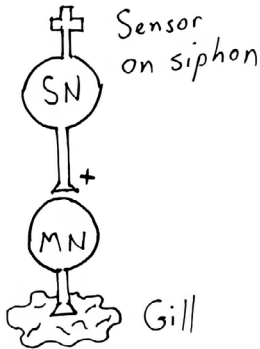

# APLYSIA SN\_EXC\_MN ROUTE DIAGRAM

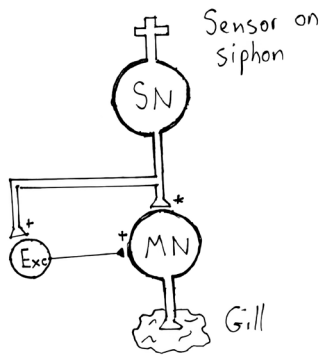

# APLYSIA SN/ MN/ EXC/ INH CIRCUITRY DIAGRAM

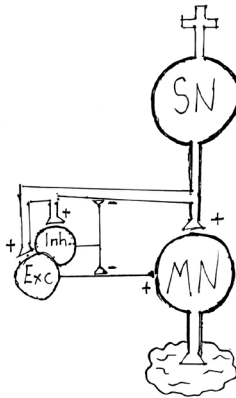

## APLYSIA TSN DIAGRAM

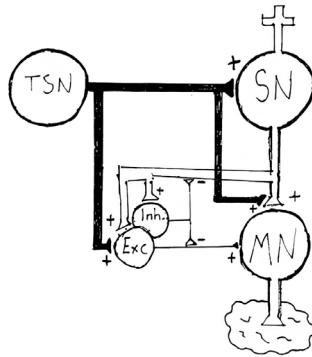

## ERIC KANDEL'S APLYSIA FIGURE 1

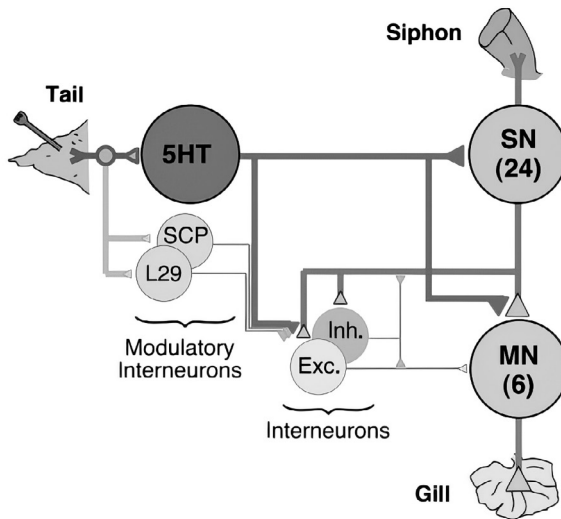

*Some minor details: 5HT is the chemical abbreviation for the neurotransmitter (serotonin) used by the TSN. SCP and L29 fine-tune the system; we've ignored them, for simplicity. There are 24 SNs in a siphon, converging on to 6 MNs.*

## APLYSIA'S GILL MECHANISM DIAGRAM 1

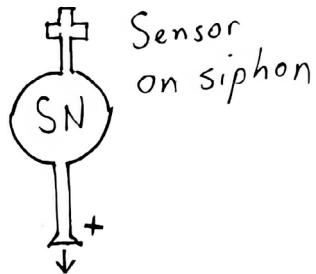

## APLYSIA'S GILL MECHANISM DIAGRAM 2

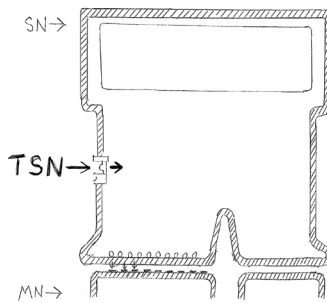

## APLYSIA'S GILL MECHANISM DIAGRAM 3

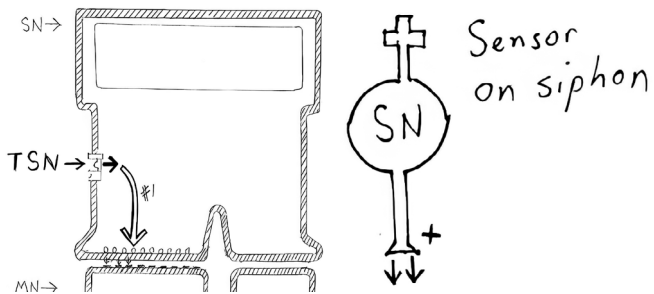

## APLYSIA'S GILL MECHANISM DIAGRAM 4

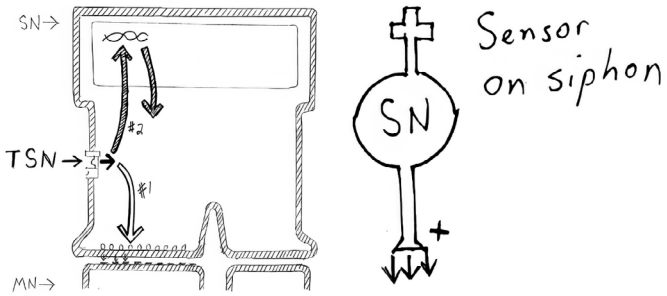

## APLYSIA'S GILL MECHANISM DIAGRAM 5

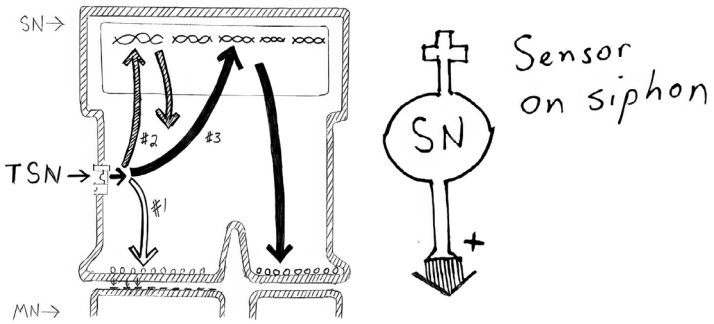

## ERIC KANDEL'S APLYSIA FIGURE 2

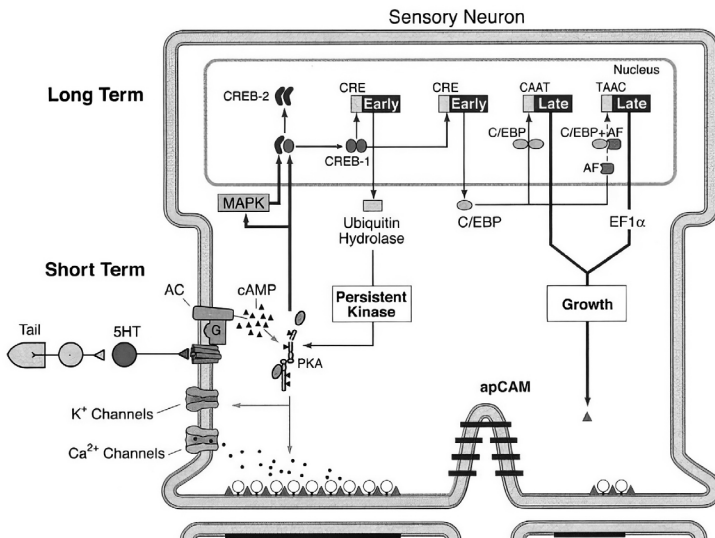

## APLYSIA CALIFORNICA PICTURE



*Aplysia californica. As should be obvious, the one on the left is happy, in an unreflective kind of way. The one on the right is a wonderful Aplysia stuffie that could be your child's comfort object all the way until their freshman year of college.*



## BLINKING EXAMPLE DIAGRAM 1



## BLINKING EXAMPLE DIAGRAM 2

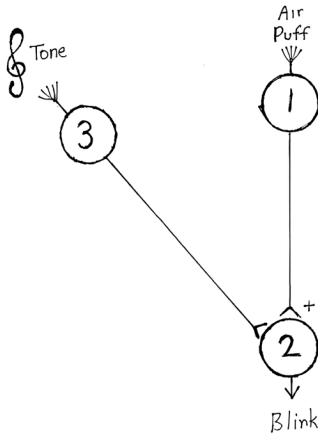

## BLINKING EXAMPLE DIAGRAM 3

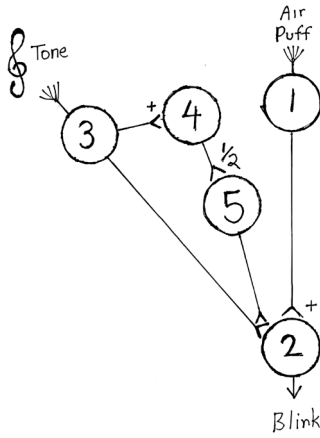

## BLINKING EXAMPLE DIAGRAM 4

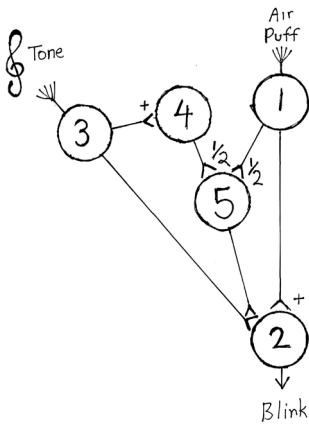

# BLINKING EXAMPLE DIAGRAM 5

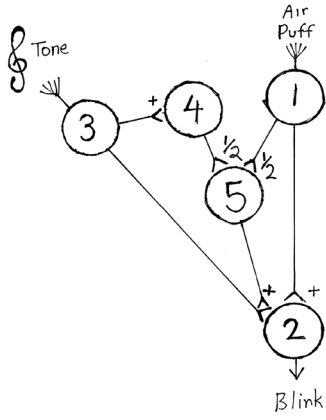

## CONDITIONED AND UNCONDITIONED STIMULUS TABLE

CONDITIONED STIMULUS AND THE PEOPLE WHO LABORED TO GENERATE THAT ASSOCIATION	UNCONDITIONED STIMULUS
1. Muslims, according to European nationalists	<i>a. Vermin, rodents</i>
2. Jews, according to the Nazis	<i>b. Thieves, pickpockets</i>
3. Indo-Pakistanis, according to half the Kenyans I know	<i>c. Opium addicts</i>
4. Irish immigrants, according to nineteenth-century WASPs	<i>d. A malignancy, a cancer</i>
5. Roma, according to centuries of Europeans	<i>e. Violent superpredators</i>
6. Mexicans, according to Donald Trump (this is a freebie thrown in)	<i>f. Rapists</i>
7. Young African American men, according to swaths of White America	<i>g. Shop owners who cheat you</i>
8. Chinese immigrants, according to nineteenth-century America	<i>h. Cockroaches</i>
9. Tutsi, according to the Hutu architects of the Rwandan genocide	<i>i. Drunken Papists</i>

HYPOTHETICAL NEURONAL CIRCUIT  
DIAGRAM 1

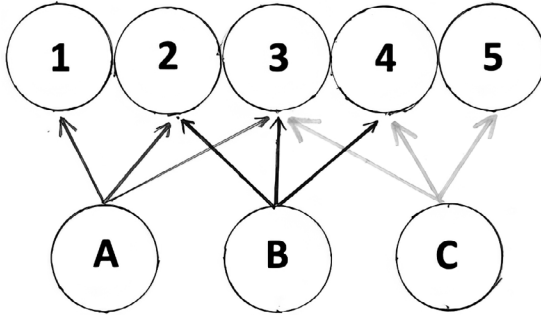

HYPOTHETICAL NEURONAL CIRCUIT  
DIAGRAM 2

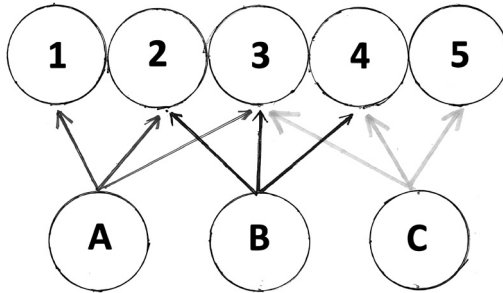

# HYPOTHETICAL NEURONAL CIRCUIT DIAGRAM 3

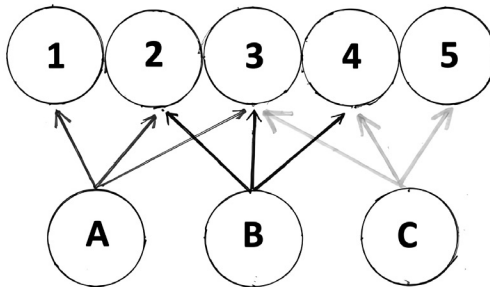
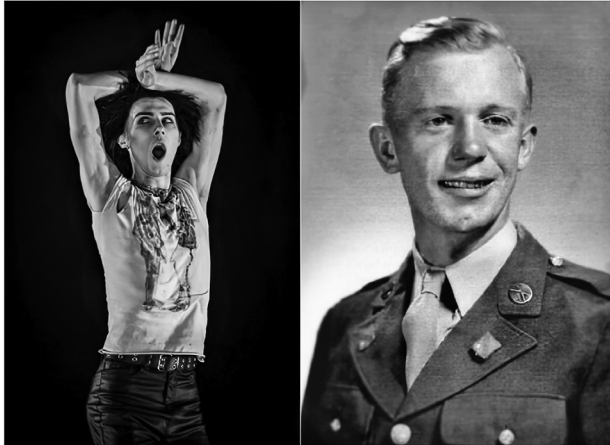

HYPOTHETICAL NEURONAL CIRCUIT  
DIAGRAM 4

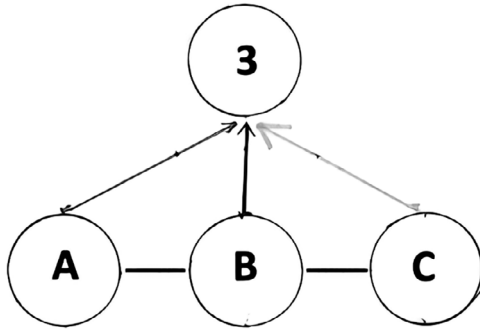

HYPOTHETICAL NEURONAL CIRCUIT  
DIAGRAM 5

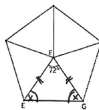
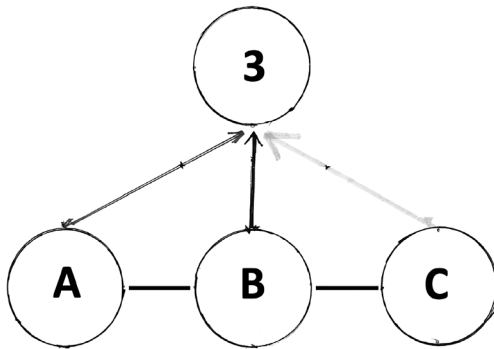

# HYPOTHETICAL NEURONAL CIRCUIT DIAGRAM 6

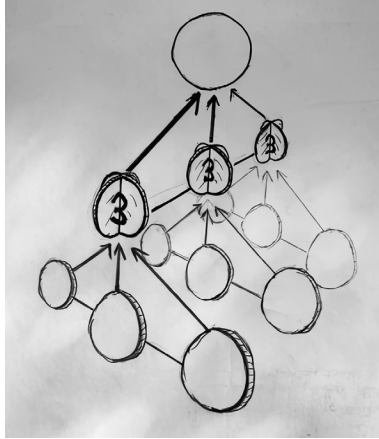

# IDENTICAL TWINS BRAIN FIGURE

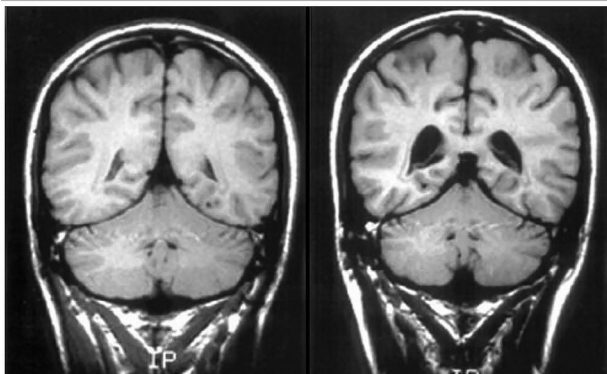

*The photograph displayed by Torrey*



PICTURE



PICTURE



PICTURE



PICTURE



PICTURE



PICTURE

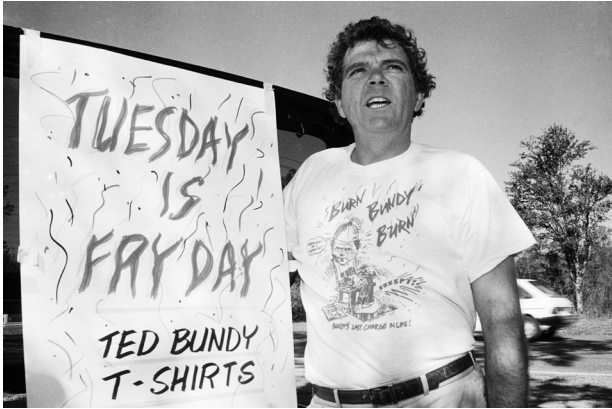

PICTURE

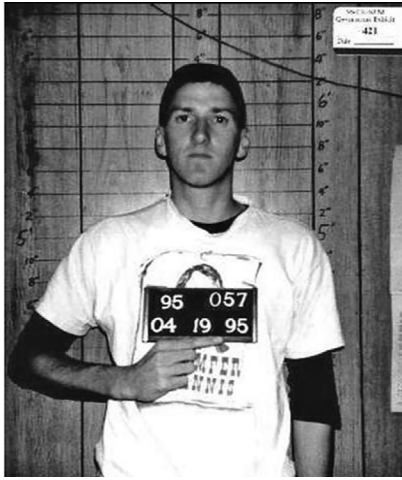

PICTURE



# SANTIAGO RAMÓN Y CAJAL NEURON DRAWING

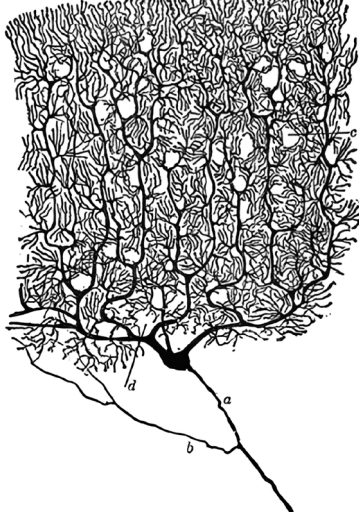

## NEURON SUBPARTS DIAGRAM

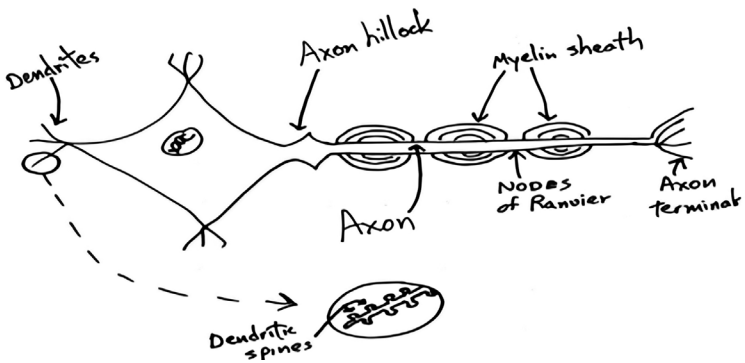

## NEUROTRANSMITTER DIAGRAM

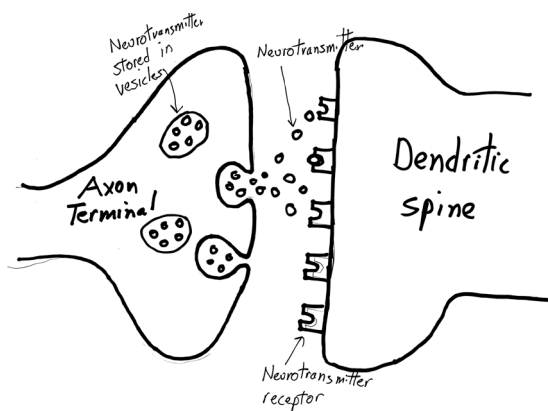

## NEUROMODULATION DIAGRAM

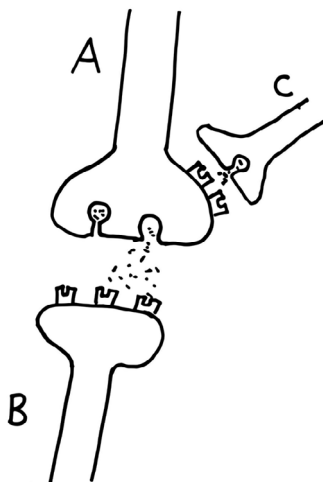

## SIGNAL SHARPENING DIAGRAM 1

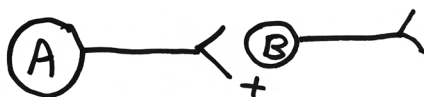

## SIGNAL SHARPENING DIAGRAM 2

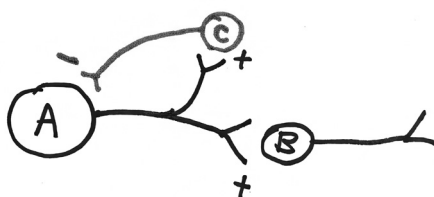

## SIGNAL SHARPENING DIAGRAM 3

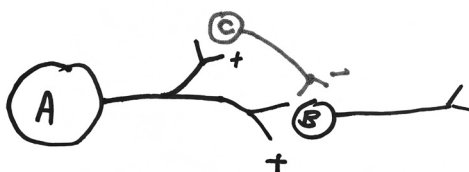

## SIGNAL SHARPENING DIAGRAM 4

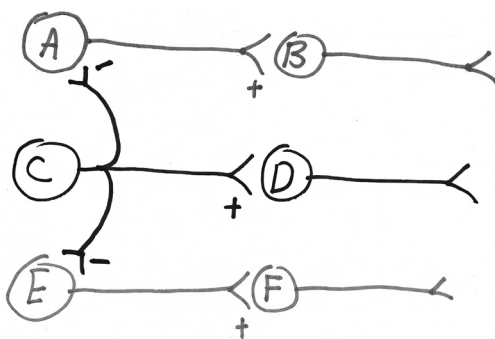

## TYPES OF PAIRN CIRCUIT DIAGRAM

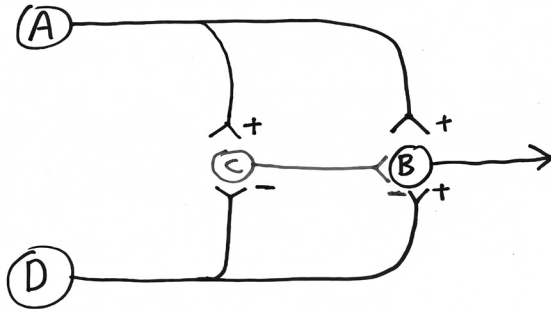



## *Footnotes*

### Chapter 1: Turtles All the Way Down

1. The “turtles all the way down” story has versions featuring other celebrated thinkers as the fall guy, rather than William James. We told our version because we liked James’s beard, and there was a building on campus named for him. The “turtles all the way down” punch line has been referenced in numerous cultural contexts, including a great book with that title by John Green (Dutton Books, 2017). All the versions of the story have a male Philosopher King Whoever being challenged by an absurd old woman, which now seems kind of sexist and ageist. That didn’t particularly register with us then, we adolescent males of our time and place.
2. My wife is a musical theater director, and I’m her rusty rehearsal pianist/generalized gofer; as a result, this book is riddled with allusions to musicals. If my college self, being ostensibly cool by referring to William James, had been told that my future included my family and me debating who was the greatest Elphaba of all time,\* I would have been astonished—“Musicals? Broadway MUSICALS?! What about atonalism?” It’s not what I asked for; sometimes life just slips in through a back door.  
(\*Idina Menzel. Obviously.)
3. The appendix is an introduction to neuroscience, for readers without a background in this area. Also, anyone who has read an agonizingly long book that I wrote (*Behave: The Biology of Humans at Our Best and Worst*, Penguin Press, 2017) will recognize the book summarized in the next few paragraphs: Why did that behavior occur? Because of events one second before, one minute . . . one century . . . one hundred million years before.
4. “Interactions” implies that those biological influences are meaningless outside the context of social environment (as well as the reverse). They’re

- inseparable. My orientation happens to be biological, and analyzing the inseparability from that angle is clearest in my mind. But at times, framing the inseparability from a biological rather than a social science perspective makes things clunky; I've tried to avoid that to the best of my biologist abilities.
5. Some of the most extreme “there’s NO free will” fellow travelers include philosophers such as Gregg Caruso, Derk Pereboom, Neil Levy, and Galen Strawson; I’ll often be discussing their thinking in the pages to come; as an important point, while all reject free will in the everyday sense we understand it when justifying punishment and reward, their rejection is not particularly along biological grounds. In terms of rejecting free will almost entirely on biological grounds, my views are closest to those of Sam Harris, who, appropriately, is not only a philosopher, but a neuroscientist as well.
  6. That said, there are a few rare diseases that are guaranteed to alter behavior because of a mutation in a single gene (e.g., Tay-Sachs, Huntington’s, and Gaucher diseases). Nonetheless, this isn’t remotely related to issues of our everyday sense of free will, as these diseases cause massive damage in the brain.
  7. I’d like to note something in preparation for my spending the first half of the book repeatedly saying, “They’re all wrong,” about a lot of scholars thinking about this subject. I can be intensely emotional about ideas, with some evoking the closest I can ever feel to religious awe and others seeming so appallingly wrong that I can be bristly, acerbic, arrogantly judgmental, hostile, and unfair in how I critique them. But despite that, I am majorly averse to interpersonal conflict. In other words, with a few exceptions that will be clear, none of my criticisms are meant to be personal. And as a “some of my best friends” cliché, I like being around people with a particular type of belief in free will, because they’re generally nicer people than those on “my side” and because I hope some of their peace will rub off on me. What I’m trying to say is that I hope I won’t be sounding like a jerk at times, because I very much don’t want to.
  8. Note: I won’t be considering any theologically based Judeo-Christian views about these subjects beyond this broad summary here. As far as I can tell, most of the theological discussions center around omniscience—if God’s all-knowingness includes knowing the future, how can we ever freely, willingly choose between two options (let alone be judged for our choice)? Amid the numerous takes on this, one answer is that God is

outside of time, such that past, present, and future are meaningless concepts (implying, among other things, that God could never relax by going to a movie and being pleasantly surprised by a plot turn—He always knows that the butler didn't do it). Another answer is one of the limited God, something explored by Aquinas—God cannot sin, cannot make a boulder too heavy for Him to lift, cannot make a square circle (or, as another example that I've seen offered by a surprising number of male but not female theologians, even God cannot make a married bachelor). In other words, God cannot do *everything*, He can just do whatever is possible, and foreseeing whether someone will choose good or evil is not knowable, even for Him. Related to this all, Sam Harris mordantly notes that even if we each have a soul, we sure didn't get to pick it.

9. Which I'm viewing as synonymous with "hard determinism"; all sorts of philosophers, however, make fine distinctions between the two.
10. Compatibilists make that clear. For example, one paper in the field is entitled "Free Will and Substance Dualism: The Real Scientific Threat to Free Will?" For the author, there's actually no threat to free will; there's a threat, though, of irksome scientists thinking they've scored points against compatibilists by labeling them as substance dualists. Because, to paraphrase a number of compatibilist philosophers, saying that free will doesn't exist because substance dualism is mythical is like saying that love doesn't exist because Cupid is mythical.

## Chapter 2: The Final Three Minutes of a Movie

1. Revisionism suggests that rather than at the inauguration, he caught his pneumonia a few weeks later when, again coatless, he went out to buy a cow. But then even more radical revisionism suggests that he didn't die of pneumonia at all but instead from typhoid fever, contracted from the vile, contaminated water available in the White House. This was concluded by writer Jane McHugh and physician Philip Mackowiak, based on the symptoms detailed by Harrison's doctor and the fact that the White House's water supply was just downstream from where "night soil" was dumped. At the time, Washington, DC, was a malarial swamp, its selection having been advocated by powerful Virginians who wanted the capital

close to home; this was decided in behind-closed-doors horse-trading between Alexander Hamilton and Virginians Thomas Jefferson and James Madison. “No one really knows how the game is played, the art of the trade, how the sausage gets made,” writes noted historian Lin-Manuel Miranda, referring to the mystery of what transpired in those negotiations.

2. As a point applying to virtually every scientific finding that I’ll discuss in the rest of the book, when I say, “work done by John/Jane Doe,” it actually means work done by that lead scientist along with a team of collaborators. As an equally important point (that I’ll reiterate in various places, because it can’t be mentioned too often), when I say, “Scientists showed that when they’d do this or that, people would do X,” I mean that *on average*, people responded this way. There are always exceptions, who are often the most interesting.
3. In the Libet literature, this point where people thought that they had decided came to be called “W,” for the point where they first consciously wished to do something. I’m avoiding using that term, to minimize jargon.
4. One paper analyzes the reporting of Libet in the lay press. Eleven percent of the headlines said free will had been disproved; 11 percent said the opposite; many articles were wildly inaccurate in describing how the experiment was done (e.g., saying that it was the researcher who would push the button). And on other fronts, there’s even a piece of music called “Libet’s Delay.” It’s moody and so repetitive that I felt a conscious sense of wishing to scream; I can only conclude that it was composed by a deeply depressed AI.
5. I’m using “the conclusion from Libet” rather than “Libet’s conclusion,” in that the latter suggests what Libet himself was thinking about his finding. We’ll get to what he thought.
6. One neuroscientist aptly describes the SMA as the “gateway” by which the PFC talks to your muscles.
7. Haynes and colleagues have since identified the exact subregion of the PFC involved. They also implicated an additional brain region, the parietal cortex, as part of the decision-making process.
8. The parietal cortex, mentioned a few footnotes back.
9. As a technical detail completely unrelated to any of this, the right half

(hemisphere) of the brain regulates movements in the left half of the body; the left hemisphere the reverse.

10. Anarchic hand syndrome, and the closely related “alien hand syndrome,” is sometimes called “Dr. Strangelove syndrome”—for the titular character in the 1964 Stanley Kubrick movie. Strangelove was mostly modeled after rocket scientist Wernher von Braun, who went from faithfully serving his Nazi masters during World War II to serving his American ones after; turns out he was a patriotic American all along, that whole Nazi thing just a misunderstanding. Strangelove, wheelchair bound after a stroke, has anarchic hand syndrome, his hand constantly trying to give a Nazi salute to his American overlords. Stanley Kubrick, the famed director of the movie, also incorporated elements of John von Neumann, Herman Kahn, and Edward Teller into Strangelove (but not, despite urban legends, Henry Kissinger).
11. Interestingly, people with depression are resistant to being tricked into this sense of “illusory will.” This will be returned to in the final chapter.
12. In TMS, an electromagnetic coil is placed on the scalp and used to activate or inactivate the patch of cortex just beneath (I had that done to me once, with the colleague controlling when I bent my index finger; it felt beyond creepy). How’s this for a finding whose implications resonate through this book? TMS can be used to alter people’s judgments of the moral appropriateness of a behavior.
13. Although, in response to this, philosopher Peter Tse of Dartmouth writes, “Just as the existence of visual illusions does not prove that all vision is illusory, the existence of illusions of conscious agency does not prove that conscious operations cannot be causal of action in certain cases.”
14. While usually classified as a philosopher, Roskies leaves the rest of us pikers in the dust by having a PhD in neuroscience, in addition to her philosophy PhD.
15. Naturally, it turns out that the neurological distinction between consciousness and unconscious is not boring, simple, or dichotomous, but that’s another can of worms.
16. Note that while related, this is subtly different from the issue of whether the sense of conscious decision-making always occurs with the same time lag after the readiness potential; as we saw, the timing of that sense of

agency can be manipulated by other factors.

17. The study was a collaboration not just between philosophers and neuroscientists but also between people with decidedly incompatibilist stances (Wheatley) and the notable compatibilists Roskies, Tse, and Duke philosopher Walter Sinnott-Armstrong. This is the process of questing for knowledge at its objective best.
18. As a fascinating finding in these studies, failing to stop in time activates the anterior cingulate cortex, a brain region associated with subjective feelings of pain; in other words, a few dozen milliseconds is enough time for you to feel like a loser because a computer has gotten a faster draw on you.
19. Depending on the study, the “*pre-SMA*,” anterior frontomedial cortex, and/or right inferior frontal gyrus. Note that the last two places, logically, implicate the frontal cortex in executive vetoing.
20. The original Libet publication didn’t mention anything about flattening out; it was only in a later review that he decided that it occurred. And to be a bit of a killjoy, after looking at the original paper, which had only four subjects, I just don’t see it in the shapes of the readiness potentials displayed, and there’s no real way to rigorously analyze the shape of each curve, given the data available in the paper; this study happened during a less quantitative, more innocent time for analyzing data.
21. Continuing to gamble activated brain regions associated with incentives and reward; in contrast, quitting activated regions related to subjective pain, anxiety, and conflict. This is amazing—continuing to gamble with the possibility of losing is less neurobiologically aversive than quitting and contemplating the possibility that you *would have* won if you hadn’t stopped. We’re a really screwed-up species.
22. It seems intuitive that someone should be punished if they thought they had willingly chosen to do something illegal without knowing that they actually didn’t have a choice. The late Princeton philosopher Harry Frankfurt has taken the implications of this intuition in a particular compatibilist direction. Step 1: Incompatibilists say that if the world is deterministic, there shouldn’t be moral responsibility. Step 2: Consider someone choosing to do something, not knowing that they would have been coerced if they hadn’t. Step 3: Therefore, this would be a deterministic world, in that the person didn’t actually have the option of doing otherwise . . . yet our intuitions are to hold him morally responsible,

perceiving him as having had free will. Huzzah, we've thus just proven that free will and moral responsibility are compatible with determinism. I feel bad saying this because Frankfurt looks cherubic in his pictures, but this seems like more than a bit of sophistry and sure doesn't represent the Demise of Incompatibilism. Moreover, I get the sense from friends in the know that while Frankfurt is enormously influential in some corners of legal philosophy, millennia go by without these "Frankfurt counterexamples" being relevant in an actual courtroom; it is unlikely for there to be scenarios where "the defendant chose to slap the Oscar host across the face, not aware that if he had not chosen to do so, he would nevertheless have been forced to."

23. Aha!
24. The Dalai Lama was once asked what he would do in the "runaway trolley" problem (a trolley whose brakes have failed is hurtling down the tracks, about to kill five people; is it okay to push someone in front of the trolley, intentionally killing them but preventing the deaths of five?); he said he would throw himself in front of the trolley.
25. This contrast between proximal versus distal explanations of behavior (i.e., causes in proximity to a behavior versus those at a distance) is caught perfectly by neurosurgeon Rickard Sjöberg of Umeå University, Sweden. He imagines walking down a hall of his hospital and someone asking him why he just put his left foot in front of his right foot. Yes, one type of reply plunges us into the world of readiness potentials and milliseconds. But equally valid replies would be "Because when I woke up this morning, I decided not to call in sick" or "Because I decided to pursue a neurosurgery residency despite knowing about the long on-call hours." Sjöberg has done important work on the effects of removing the SMA on issues of volition, and in an extremely judicious review concludes that whatever resolution there is to free will debates, it isn't going to be found in the milliseconds of SMA activity.
26. A point elegantly argued by philosopher Gregg Caruso in some stirring debates with Dennett.

## Chapter 3: Where Does Intent Come From?

1. If you have read my book *Behave*, you'll recognize that the rest of this chapter is a summary of its first four hundred or so pages. Good luck . . .
2. I'm being diplomatic. Many readers will know of the "replication crisis" in psychology, where an alarming percentage of published findings, even some in textbooks, turn out to be hard or impossible for other scientists to independently replicate (including some findings, I admit ruefully, that wound up being cited in my 2017 book, where I should have been more discerning). Thus, this section considers only findings whose broad conclusions have been independently replicated.
3. For DIYers, the paper contained the imitation vomit recipe: cream of mushroom soup, cream of chicken soup, black beans, pieces of fried gluten; quantities were unspecified, suggesting that you just have to get a feel for this sort of thing—a pinch of this, a smidgen of that. The study also noted that this recipe was *partially* based on one in a prior study—i.e., plucky innovation is advancing imitation-vomit science.
4. The region was the dorsomedial PFC, as shown with transcranial magnetic stimulation. As a control, no effect was seen when inhibiting the more "cerebral" dorsolateral PFC. Lots more on these brain regions in the next chapter.
5. And don't forget Pontius Pilate being reported to "wash his hands" of that crucifixion bother.
6. Psychology fans will recognize how this study supports the James-Lange theory of emotion (yes, William James!). In its modern incarnation, it posits that our brain "decides" how strongly we feel about something, in part, by canvassing interoceptive info from the body; for example, if your heart is racing (thanks to unknowingly being given an adrenaline-like drug), you perceive your feelings as being more intense.
7. With at least one paper inevitably making reference in its title to "hunger games." By the way, in chapter 11, we'll be looking at a really key circumstance where there is a major discrepancy between how charitable people say they are and how much they actually are.



8. Regardless of your sex, since both secrete T (albeit in differing amounts) and have T receptors in the brain. The hormone has broadly similar effects in both sexes, just typically more strongly in males.
9. These are almost always “double-blind” studies, in which half the subjects get the hormone, the rest get saline, and neither the subjects nor the researchers testing them know who got which.
10. What do I mean by T “strengthening” a projection from the amygdala to another part of the brain (the basal ganglia, in this case)? The amygdala is particularly sensitive to T, has lots of receptors for it; T lowers the threshold for amygdaloid neurons to have action potentials, making it more likely—“strengthening”—that a signal would propagate from one neuron to the next, down the line. Meanwhile, T is having the opposite effect when “weakening” projections. Dotting i’s and crossing t’s—T receptors are technically called androgen receptors, reflecting there being an array of “androgenic” hormones, with T as the most powerful. We’re going to ignore that for all-around sanity.
11. Just as an important complication, testosterone can make people more prosocial under circumstances where doing so gains them status (for example, in an economic game where status is gained by making more generous offers). In other words, testosterone is about aggression only under circumstances where the right type of aggression gets you high status.
12. Note before how testosterone can have opposite effects on neurons in two different parts of the brain. Here we have oxytocin having opposite effects on behavior in two different social contexts.
13. Minor detail: Glucocorticoids, coming from the adrenal gland during stress, are different from adrenaline, also coming from the adrenal during stress. Different hormone classes but broadly similar effects. The major glucocorticoid in humans and other primates is cortisol, aka hydrocortisone.
14. For what it’s worth, and as a demonstration of how narrow the focus of science can be, I spent more than three decades of my life obsessing over issues related to the last four paragraphs.
15. Time to step into a minefield. Since humans first learned to make fire,

introductory neuroscience classes taught that the adult brain doesn't make new neurons. Then, starting in the 1960s, doughty pioneers found hints that there actually is "adult neurogenesis" after all. They were ignored for decades until the evidence became incontrovertible, and adult neurogenesis became the sexiest, most revolutionary topic in neuroscience. There have been reams of findings about how/when/why it occurs in animals, what sort of things promote it (e.g., voluntary exercise, estrogen, an enriched environment), and what inhibits it (e.g., stress, inflammation). What are the new neurons good for? Various rodent studies indicate that they contribute to stress resilience, anticipating a new reward, and something called pattern separation—once you've learned the general features of something, the new neurons help you learn distinctions among different examples of it—say, once you've learned to recognize a performance of *Next to Normal*, you rely on pattern separation in the hippocampus to teach you the difference between a performance of it on Broadway and one in a high school (the distinctions can be minimal and subtle, if the latter is in the hands of a superb director).

16. As this neurogenesis literature matured, there was evidence that the adult human brain could make new neurons also. Then an extremely thorough 2018 paper in *Nature*, using the largest number of human brains studied to date, suggested that maybe there wasn't much/any neurogenesis in the adult human brain after all (amid there being plenty in other species). Massive controversy ensued, still raging. I find that study to be convincing (but, full disclosure, I'm not really objective, since the lead author on the paper, Shawn Sorrells, now of the University of Pittsburgh, was one of my star grad students).
17. Meaning, among other things, that if someone centrifuged you and then extracted your DNA, if they were not careful, they'd mostly be inadvertently studying the DNA of your gut bacteria.
18. There is a neuron type called the von Economo neuron (VEN) that is found pretty much only in two brain regions tightly linked to the frontal cortex—the insular cortex and the anterior cingulate cortex. For a while, there was massive excitement in that it appeared to be a neuron type unique to humans, a first. But things were actually even more interesting—VENs also occur in the brains of some of the most socially complex species on earth, such as other apes, cetaceans, and elephants. No one is quite sure what they are for, but there's been some progress. But despite VENs' existence, the similarities between the building blocks of the frontal cortex and the rest of the cortex are much greater than the differences.

19. Note: “Everything in the brain” includes the frontal cortex; amid the drama of delayed maturation, a substantial percentage of its construction occurs during childhood.
20. Naturally, there are problems with an overly literal reliance on stage - thinking—the transitions from one stage to the next can be smooth continua, rather than crossings of distinctive borders; a child’s stage of, say, moral reasoning may differ with differing emotional states; insights have mostly come from studies of boys in Western cultures. Nonetheless, the basic idea is really useful.
21. Whoa, different rat mothers mother differently? Sure, with variation as to how often they groom or licks their pups, respond to their vocalizations, and so on. This is landmark work pioneered by neuroscientist Michael Meaney of McGill University.
22. The same effect holds for sports. Professional athletic teams are way disproportionately filled with players who were older than average in their childhood sports cohort.
23. These effects on fetuses were first identified in humans in two horrifically unnatural “natural experiments of starvation”—the Dutch Hunger Winter of 1944, when Holland was starved by the occupying Nazis, and the Great Leap Forward famine in China in the late 1950s.
24. For those with a background in this, it’s worth noting a few of the things that I ignored in this paragraph: the intronic/exonic structure of genes, gene splicing, multiple conformations in prion proteins, transposons, genes coding for small interfering RNA, and RNA enzymes . . .
25. Things left out of this paragraph: transcription factors, signal transduction pathways, the fact that it is only steroid hormones, in contrast to peptidergic hormones, which directly regulate transcription . . .
26. Some of the things left out here: promoters and other regulatory elements in DNA, transcriptional cofactors imparting tissue specificity of gene transcription, selfish DNA derived from self-replicating retroviruses . . .
27. Things left out include how simplistic it is to focus on a single gene and its singular effect, even after accounting for environment. This is because of pleiotropic and polygenic genetic effects; startling evidence for the

importance of the latter comes from genome-wide survey studies, indicating that even the most boringly straightforward human traits, such as height, are coded for by hundreds of different genes.

28. Some of the things left out: homozygosity versus heterozygosity, dominant versus recessive traits . . .
29. Aficionados: the genes coding for tryptophan hydroxylase and aromatic amino acid decarboxylase, the 5HTT serotonin transporter, monoamine - oxidase-alpha, respectively.
30. More details: the genes for tyrosine hydroxylase, the DAT dopamine transporter, catechol-O-methyltransferase.
31. If each of those polymorphic spots comes in one of merely two possible versions, the number of different genetic makeups would be two to the four millionth power, a pretty good approximation of infinity—two to the mere fortieth power is something like a trillion.
32. Just to reiterate a point about every fact in this chapter: These are broad populational differences that differ with statistical significance from chance, not reliable predictors of every individual's behavior. Every statement is tacitly preceded by "*on the average.*"
33. As an example that floored me, an irrigation system near Djuangyan City in China irrigates five thousand square kilometers of rice fields and has been collectively used and maintained for *two thousand* years.
34. To introduce a hot potato, are there genetic differences between individualist and collective cultures? Whatever there are can't be too important; after a generation or two, descendants of Asian American immigrants are as individualistic as European Americans. Nonetheless, genetics differences have been found that are *so* interesting. Consider the gene DRD4, which codes for a dopamine receptor. You know, dopamine—that's about motivation, anticipation, and reward. One DRD4 variant makes a receptor that is less responsive to dopamine and increases the likelihood of novelty seeking, extroversion, and impulsivity in people. Europeans and European Americans: a 23 percent incidence of that variant. East Asians: 1 percent, a difference way above chance, suggesting the variant being selected *against* in East Asia for thousands of years.
35. Among the pastoralist Maasai I've lived near in Africa, group violence

increasingly revolves around clashes with neighboring agricultural folks, -Sharks-versus-Jets moments in market areas visited by both. But the historical enemies of my Maasai are the Kuria people of Tanzania, pastoralists prone to cattle rustling from Maasai at night; this leads to -spear-laden retributive raids that can kill dozens. As a measure of the combativeness of the Kuria, after independence, Tanzania's army was 50 percent Kuria, despite their being only 1 percent of the population.

36. As a great experimental example, stage things so that your male subject is insulted by someone; if they come from the South, there is a huge increase in circulating cortisol and testosterone levels and an increased likelihood of advocating a violent response to a hypothetical honor violation (relative to uninsulted Southern subjects). Northerners? No such changes.
37. The infectious-disease link may help explain the additional finding that cultures originating in the tropics tend toward more extreme in-group/out-group differentiation than cultures from regions farther from the equator. Temperate ecosystems make for cultures that are more temperate about outsiders.
38. And as a possible neurobiological underpinning of this, consider people from cities, suburbs, and rural areas. The larger the population someone grew up in, the more reactive their amygdala is likely to be during stress. This has prompted various articles with titles revolving around "Stress and the City."
39. As a final vote for the power of ecological influences underlying many of these cultural patterns, humans and other animals living in the same ecosystem tend to share numerous traits. For example, high levels of biodiversity in a particular ecosystem predict high levels of linguistic diversity among the humans living there (and places where large numbers of species are in danger of extinction are also where languages and cultures are most at risk of extinction). A study of 339 hunter-gatherer cultures from around the world showed even more dramatic convergence between humans and other animals—human cultures with high degrees of polygamy tend (at higher-than-chance level) to be surrounded by other animals with high rates of the same. There is also human/animal covariance in likelihood of males helping to take care of kids, of storing food, and of subsisting predominantly on a fish diet. And statistically, the human/animal resemblances are explained by ecological features like latitude, altitude, rainfall, and extreme versus temperate weather. Once again, we're just another animal, if a weird one.

40. It's worth noting that similar, if not identical, types of turtles all the way down also explain why, say, some chimp is the most gifted member of her generation at making tools: good social and observational skills allowing her to hang out closely and learn the trade from an older master, impulse control allowing patience with trial and error, attention to detail, the combination of innovativeness and the confidence to ignore how the cool kids are doing it—all arising from events one minute before, one hour before, and so on. Not a smidgen of “when the going gets tough, tough chimps *choose to* get going.”
41. This approach is implicit in the thinking of Cornell philosopher Derk Pereboom; he posits four scenarios: you do something awful because (1) scientists manipulated your brain a second ago; (2) they manipulated your childhood experiences; (3) they manipulated the culture you were raised in; (4) they manipulated the physical nature of the universe. These are ultimately equally deterministic scenarios, though most people's intuitions solidly view the first as far more so than the other three, because of its close proximity to the behavior itself.
42. Mind you, the compatibilist Tse isn't pleased with this, writing somewhere between how this regress can't exist and how it shouldn't exist—a contrast that anchors parts of chapter 15.
43. As a small clarification, Levy doesn't necessarily believe that we have *no* control over our actions, just that we have no relevant control.
44. Levy has an interesting analysis that focuses on a file-this-away-for-future-use word, *akrasia*, which is when an agent acts against her expressed judgment. When certain akrasias become common enough, we have seemingly insoluble inconsistencies . . . until we generate a view of ourselves that consistently accommodates the akrasia. “I'm normally a very self-disciplined person . . . except when it comes to chocolate.”
45. “Forever” may not really be the case because, at some point in this regression, you get to the big bang and whatever came before that, about which I understand precisely zero. Regardless of whether things go back infinitely, as a key point, the further back you go, the smaller the influence is likely to be—how you respond to this stranger who may have just insulted you is more influenced by your circulating stress hormone levels at the time than by the infectious-disease load experienced by your distant ancestors. When trying to explain our behavior, I'm perfectly happy to call

a time-out on “what came before that” when it’s going far enough back to explain, say, why we’re a carbon-based rather than silicon-based life form. But we have ample evidence for the relevance of what-came-befores that people used to feel justified in ignoring—the trauma that occurred a few months before a person behaved as they did, the ideal level of stimulation experienced in their childhood, the alcohol levels their fetal brain was pickled in . . .

## Chapter 4: Willing Willpower: The Myth of Grit

1. I’ve testified saying something like this paragraph to about a dozen juries as a teaching witness, in case after case where someone with that sort of life story had a few seconds to make a similar decision and went back to the prone assailant and stabbed him an additional sixty-two times. So far, with one exception that I now view as a fluke, the juries have decided that it’s premeditated murder and convicted on all charges.
2. To my surprise, some studies have shown that high-IQ kids are more prone than average toward illegal drug use and alcohol abuse in adulthood.
3. Perfect pitch is actually a classic example of genes being about potential, not certainty. Research suggests that you probably need to have inherited the potential for perfect pitch; however, it is not expressed in someone unless they were exposed to a fair amount of music early in life.
4. Neuroanatomists will turn over in their graves, but from here on out, I’m going to refer to the entire frontal cortex as the PFC, for simplicity’s sake.
5. Which tells you something very important about primate dominance. For example, for a male baboon, attaining high rank is all about muscles, sharp canines, and winning the right fight. But *maintaining* high rank is about avoiding fights, having the self-control to ignore provocations, avoiding fighting by being psychologically intimidating, being a sufficiently self-disciplined, stable coalition partner (unlike Finn) to always have someone watching your back. An alpha male who is constantly fighting won’t be in the corner office long; successful alphaship is a minimalist art of nonwar.
6. There’s a world of complexity to this. It depends on whom the picture is - of—strapping young guy, and the amygdala roars into activity; frail,

grandmotherly type, not so much. More for a stranger than for an other-race beloved celebrity—that person counts as an honorary Us. What about the 25 percent of people who don't have the amygdala response? They were typically raised in multiracial communities, have had intimate relationships with people of that other race, or have been psychologically primed before the experiment to process each face as an individual. In other words, the implicit racism coded in the amygdala is not remotely inevitable.

7. These studies have produced another distressing finding. When we look at faces, there is activation of a very primate part of the cortex called the fusiform face area. And in most subjects, the face of an other-race Them activates the fusiform less than usual. Their face doesn't count as being much of a face.
8. Studies like this include a key control, showing that it is social anxiety that is being generated: the other two stop tossing the ball to the subject, who is told that it's because of some problem with the computer. If it's that, rather than social ostracism, there's no equivalent brain response.
9. Depressing finding: Instead of conditioning subjects to a neutral, innocuous object, condition them to a picture of an out-group Them. People learn to associate that with a shock faster than if it were an in-group member.
10. Is the PFC causing the amygdala to forget that bells are scary? No—the insight is still there but is just being suppressed by frontal cortex. How can you tell this? On day three of the study, go back to the sight of that arbitrary object being followed by a shock. The person relearns the association faster than they learned it in the first place—the amygdala remembers.
11. Here are some factoids that emphasize the extent to which social demands sculpt the evolution of the PFC. The PFC contains a neuron type not found elsewhere in the brain. To add to its coolness, for a while people thought that these “von Economo neurons,” introduced in the footnote on page 61, occurred only in humans. But as something even cooler, the neurons also occur in the most socially complex species out there—other apes, elephants, cetaceans. A neurological disease called behavioral frontotemporal dementia demonstrates that PFC damage causes inappropriate social behavior. What are the first neurons that die in that disease? The von Economo neurons. So whatever they do (which isn't at all clear), it has “doing the harder thing” written all over it. (Brief screed of



interest to only a few readers—despite quasi–New Age neuroscientific claims, von Economo neurons are not mirror neurons responsible for empathy. These aren’t mirror neurons. And mirror neurons don’t do empathy. Don’t get me started.)

12. Such as the hippocampus, septum, habenula, hypothalamus, mammillary bodies, and nucleus accumbens.
13. And of considerable importance, we’ll be getting to circumstances where the limbic system convinces the PFC to rubber-stamp strongly emotional decisions.
14. Heads up, running-dog capitalists: one study has used TMS to manipulate the projection from the dlPFC to dopaminergic reward pathways in the striatum, thereby transiently changing people’s music tastes—enhancing the subjective appreciation of a piece of music and the physiological response to it . . . as well as boosting the monetary value subjects assign to the music.
15. Starting in the 1960s, the esteemed neuroanatomist Walle Nauta of MIT nearly ruined his career by stating that the vmPFC should be viewed as part of the limbic system. Horror—the cortex is about solving Fermat’s theorem, not getting all weepy when Mimi is dying in Roger’s arms. And it took years for everyone else to see that the vmPFC is the limbic system’s portal to the PFC.
16. Cash = ATP, aka adenosine triphosphate, just to tap into the recesses of your memory, dredging up a factoid from ninth-grade biology.
17. Similar concepts that are invoked include “ego depletion” and “decision fatigue.” See notes for how the core concepts of cognitive reserve and ego depletion have been heavily criticized in recent years.
18. The finding was challenged by some critics who suggested that it was a statistical artifact of the way parole hearings were carried out; the authors reanalyzed their data to control for these possibilities, convincingly showing that the effect was still there. An additional study showed the identical pattern: subjects read job applicant profiles from out-group minority members; the longer it had been since a meal, the less time was spent on each application.
19. “My god, this guy is such a bleeding-heart liberal.” Nah. *Way* beyond -

that—you'll see.

20. In the same vein, credit loan officers become more likely to turn down loan applications as the day progresses. Similarly, savvy actors know not to pick the time slot just before lunch or at the end of the day for auditioning.
21. How was this learned? The hard way. Parkinson's disease, a movement disorder where initiating voluntary movements becomes difficult, is caused by a dearth of dopamine in an unrelated part of the brain. Well, let's treat that by raising the person's dopamine levels (done using a drug called L-DOPA; long story). You're not going to drill a hole in the person's head and infuse L-DOPA directly into that part of the brain. Instead, the person swallows an L-DOPA pill, resulting in more dopamine in that diseased part of the brain . . . as well as in the rest of the brain, including the PFC. Result? A side effect of high-dose L-DOPA regimes can be behaviors like compulsive gambling.
22. Uh, what's this experiment about? The scared sweat came from swabbing the armpits of people after their first skydive. What's the control group? Sweat from happy people who have just had an enjoyable jog in the park. Science is the best; I love this stuff.
23. By the way, heterosexual women don't start acting in equivalently stupid ways because of the proximity of some hunk. Another study showed that male skateboarders did riskier tricks, with more crashes, when in proximity of an attractive woman. (Just to show that all the science was rigorous, attractiveness was assessed by teams of independent raters. And in the words of the authors, "attractiveness ratings were corroborated by many informal comments and phone number requests from the skateboarders").
24. Minutia: not just in the ventromedial PFC but in the entire "medial PFC."
25. Brain-Derived Neurotrophic Factor.
26. By the way, *psychopathy* and *sociopathy* are not the same, and I have the same challenge keeping them straight as I do with using *that* or *which*. There are crucial differences between the two. Nevertheless, barbarians that we are, we will focus on the similarities and use the terms interchangeably.
27. Elevated rates compared with whom? Nobel Peace Prize winners? The comparison groups in this literature are demographically matched

nonincarcerated subjects and/or matched controls in prison for nonviolent crimes.

28. Just to recall something from chapter 3, frontocortical maturation during adolescence doesn't consist of the last lap of building new synapses, neuronal projections, and circuits. Instead, the early-adolescent frontal cortex has *more* of those things, is proportionately bigger, than the adult frontal cortex. In other words, frontocortical maturation during this period consists of pruning away the superfluous, less efficient circuits and synapses, whittling down to your adult frontal cortex.
29. Even though PFC development is not completed until the midtwenties, construction on it begins in fetal life.
30. Which means that the vicious cycle noted earlier about adults applies to kids as well—elevated glucocorticoid levels make for a weaker developing PFC; insofar as part of what the PFC does is turn off glucocorticoid stress responses, this weakened PFC adds to glucocorticoid levels rising even higher.
31. Influences from the world outside a child's family are shown in a related literature: everything else being equal, growing up in an urban setting (versus suburban or rural) predicts less gray matter volume in the different parts of the PFC in adults, a more reactive amygdala, and more glucocorticoid secretion in response to social stress (where the bigger the size of the city in childhood, the more reactive the amygdala). Moreover, cortical brain development in newborns is predicted not only by familial social disadvantage but by neighborhood crime rates as well.
32. The finding involved structural MRI imaging of the fetal brain. Note that these findings about fetuses and newborns consider only development of the cortex, rather than specifically in the frontal cortex. This is because it's just too hard to discern the subregions in brain imaging at that age.
33. As a calming reminder, these are major maternal stressors, not everyday ones. Moreover, the magnitude of these effects are generally mild (with an exception being if the adversity that the fetus experiences includes maternal alcohol or drug abuse).
34. Note that the variability in a trait in a population is determined by the degree of variability in genes (i.e., a "heritability score"). This is a hugely controversial subject, often producing glass-half-empty/glass-half-full

differences as to whether a result is indicating how important or how unimportant a gene is. For a detailed but nontechnical overview of the behavior genetics controversies, see chapter 8 in my book *Behave: The Biology of Humans at Our Best and Worst*.

35. For detail enthusiasts, the protein that removes serotonin is called the serotonin transporter; the protein that degrades serotonin is called MAO--alpha; the receptor is the 5HT2A receptor.
36. Stress and adversity are bad for PFC development and, interestingly, this takes the form of *accelerated* maturation. Faster maturation equals the door being shut sooner on how much environment can foster optimal PFC growth.
37. A few of the studies focused on Western Europeans rather than North Americans, with the same general differences from East Asian cultures.
38. Reminding once again that these are differences in *average* degrees of traits, populational differences with lots of individual exceptions.
39. Plus one other region, the rostralateral PFC.

## Chapter 5: A Primer on Chaos

1. By William Pène du Bois, Viking Books for Young Readers, 1947.
2. James Gleick's *Chaos: Making a New Science* (first ed., Viking Press, 1987).
3. The same strategy was used to first sequence the human genome. Suppose a particular stretch of DNA is nine units of length too long to systematically figure out its sequence—the lab techniques just aren't up to it. Instead, cut that stretch into a series of fragments that are short enough to sequence, say, fragment 1/2/3, fragment 4/5/6, and fragment 7/8/9. Now take a second copy of the same stretch of DNA, and cut it into a different pattern: fragment 1, then fragment 2/3/4, then 5/6/7, then 8/9. Cut a third into 1/2, 3/4/5, and 6/7/8/9. Match up the overlapping fragments, and you now know the entire sequence.

4. Weighting variables is the outcome of transitioning from “Add variables A and B together and you get decent prediction about whatever” to “Add variables A and B together . . . , and remember that variable A is more important than variable B” to “Add variable A and B together . . . and have variable A carry, say, 3.2 times as much weight in the equation as does variable B.”
5. Which means that past and future are identical, that there is no direction of time, that events one second in the future are already the past of two seconds in the future. Which makes me feel queasy, reminding me that I’ve already died somewhere in the future.
6. People in the field spend a lot of time debating whether exponential increases are occasional, probable, or inevitable, where the outcome depends on the finite-time Lyapunov exponent. I have no idea what that means, and this footnote is totally gratuitous. The differing opinions about exponentiality are reviewed by Wheaton College philosopher/mathematician Robert Bishop, who characterizes the view that chaotic systems always have exponential increases in unpredictability as laughable “folklore.”
7. The oscillations of unpredictability around the predicted answer in a strange attractor show some dizzyingly interesting properties:

A. The first is an extension of Lorenz’s experience with his six decimal places. So the values in the chaotic oscillations never actually reach the attractor—they just keep dancing around it. You’re dubious of this chaos stuff, know that at some point, this weirdo set of results you’re getting will settle down to matching what is predicted. And that seems to - happen—your nice linear predictions say that the observed value at some point should be, say, 27 units of something. And that’s exactly what you measure. Aha, so much for this system being unpredictable. But then a chaoticist gives you a magnifying glass, and you look closely and see that the observed value wasn’t 27. It was 27.1, in contrast to the predicted 27.0. “Okay, okay,” you say. “I still don’t believe this chaos theory stuff. All we’ve just learned is that we have to be precise out to one decimal place.” And then at some point in the future, when you’ve predicted that the measure should be, say, 47.1, that’s exactly what you actually observe; goodbye, chaos theory. But the chaoticist gives you an even bigger magnifying glass, and the observed value turns out to be 47.09 instead of the predicted 47.10. Okay, that doesn’t prove that the mathematical world has chaotic elements; we just have to be precise out to two decimal places.

And then you find a discrepancy three decimal places out. And wait long enough, and you'll find one that's four decimal places out. And this goes on and on until you're dealing with an infinite number of decimal places, and the results are still not predictable (but if you could get past infinity, things would become perfectly predictable; in other words, chaos only superficially shows that Laplace was wrong—what it is mostly showing is how long infinity is). Thus, the relative magnitude of chaotic oscillations around a strange attractor stays the same, regardless of the magnification at which you're looking (something similar to the scale-free nature of fractals).

B. The oscillations around predicted values are the manifestation of their strange attraction to what is predicted. But the fact that the oscillations never actually precisely reach the predicted value (at a sufficient scale of magnification) shows that a strange attractor repels as well as attracts.

C. As a logical extension of these ideas, the pattern of oscillations around the predicted value never repeats either. Even if it looks like it oscillated to the same unpredicted point where it was at last week, look closer, and it will be slightly different. Same scale-free feature. When a dynamic pattern repeats over and over, it is referred to as being "periodic," and the pattern's infinity can be compressed into something far shorter, such as the statement "It goes like this forever" or "It alternates between these two patterns forever" (which is saying that the predictable shifting between multiple patterns *is* the pattern). In contrast, when the pattern of unpredictable oscillations around a strange attractor never repeats until the end of time, it is referred to as nonperiodic, as in the title of Lorenz's paper. And with nonperiodicity, the only possible description of an infinitely long pattern has to be as long itself. (Jorge Luis Borges wrote a very short story [i.e., one paragraph long], "On Exactitude in Science," in which a cartographer makes a perfect map of an empire, leaving out no detail; the map, of course, is as large as the empire.)

8. Ray Bradbury anticipated all of this with his 1952 short story "A Sound of Thunder." A man travels sixty million years back in time, being careful not to alter anything while there. Inevitably he does alter something, and returns to the present to find the world a different place—as Bradbury framed it, the man had knocked over a small domino that led to big dominoes falling and, eventually, gigantic ones. What was the infinitesimally small impact that he had in the past? He stepped on a butterfly. Mere coincidence that this was the metaphor suggested by Lorenz's friend? I think not.

9. The grid is 14 boxes wide; each box can be in one of 2 states; therefore, the total number of patterns possible is  $2^{14}$ , or 16,384.
10. A word pregnant with significance.
11. Cellular automata were first studied and named by the Hungarian American mathematician / physicist / computer scientist John von Neumann in the 1950s. It's virtually required by law to call him a genius. He was wildly precocious—at age six, he could divide eight-digit numbers in his head and was fluent in ancient Greek. One day when von Neumann was six, he found his mother daydreaming and he asked her, “What are you calculating?” (This contrasts with the daughter of a friend of mine, who, finding her father lost in thought, asked, “Daddy, which candy are you thinking about?”)
12. Back to our set of instructions for rule 22: Just look at the first row. As we saw, there are eight possible trios. Each trio can result in two possible states in the next generation, namely open or filled. For example, our first trio, where all three boxes in the trio are filled, could lead to either an open row 2 box (as we would get when applying rule 22) or one that is filled (as with other rules). Thus, two possible states for each of the eight trios means  $2^8$ , which equals 256, the total number of possible rules in this system.
13. As with von Neumann, it is impossible to mention Wolfram without noting that he is a major-league genius. Wolfram had written three books on particle physics by the time he was fourteen years old, was a professor at Caltech by age twenty-one, produced a computer language and a computing system called Mathematica that is widely used, helped create the language that the aliens communicated with in the movie *Arrival*, generated Wolfram's atlas of cellular automata, which allows you to play with the 256 rules, etc., etc. In 2002, he published a book called *A New Kind of Science*, which explores how computational systems like cellular automata are foundational to everything from philosophy to evolution, from biological development to postmodernism. This generated a great deal of controversy, built around the question of whether these computational systems are good ways to generate *models* of things in the real world, or to actually generate the complicated things themselves (as one piece of the critique, things in nature don't progress in discrete, synchronized “time steps” as in these models). Lots of people also weren't thrilled about the grandiosity of the claims in the book (starting with the title) or about a perceived tendency of Wolfram's to claim every idea in the

book as his own. Everyone bought a copy of it and discussed it endlessly (and hardly ever actually read the entire thing, as it was 1,192 pages long—yeah, me included).

## Chapter 6: Is Your Free Will Chaotic?

1. This study produced the now legendary 1984 paper by Robert Shaw, *The Dripping Faucet as a Model Chaotic System*, Science Frontier Express Series (Aerial Press, 1984).
2. In cardiology, healthier cardiovascular systems show more chaotic variability in the time intervals between heartbeats; in neurology, insufficient chaoticism is a marker of neurons that wind up firing at abnormally high rates in abnormally synchronized waves—a seizure. At the same time, other neuroscientists have explored how chaoticism can be exploited by the brain for enhancing some types of information transmission.
3. The popularization of the latter has also led to a proliferation that I've noted in the locations of the butterfly effect, with the different citations placing the butterfly in the likes of the Congo, Sri Lanka, the Gobi Desert, Antarctica, and Alpha Centauri. In contrast, the tornado almost always seems to be in Texas, Oklahoma, or, evoking Dorothy and Toto too, Kansas.
4. As a reminder from earlier in the book, Laplace was the eighteenth-century philosopher who stated the rallying cry of scientific determinism, namely that if you understand the physical laws shaping the universe and know the exact position of every particle in it, you could accurately predict what had happened during every moment since the start of time, and what would happen in every subsequent moment until the end of time. Which means that whatever happens in the universe was destined to happen (in a mathematical rather than theological sense).
5. With a reminder from chapter 3 that it is very rare for a single gene to be deterministic in this way. To reiterate, almost all genes are about potential and vulnerability, rather than inevitability, interacting in nonlinear ways with environment and other genes.



6. I've observed a great example of this. Near the equator in Kenya is Mount Kenya, the second-highest mountain in Africa, at more than seventeen thousand feet. Among the cool things about it, the climate is equatorial African at the base and glacial on top (at least it's glacial for a little while - longer—melting fast), with completely different ecosystems every few thousand feet higher. There are some odd-looking plant species in the montane zone at about fifteen thousand feet. I was once chatting with a plant evolutionary biologist in his office, and there were some pictures of one of those plants. "Hey, nice, I see you've been up Mount Kenya," I said. "No, I took those in the Andes." The Andean plant was completely unrelated to the Kenyan one yet looked virtually the same. Apparently, there are only a few ways to be a high-altitude plant on the equator, and these very different plant species, on opposite sides of the globe, had converged on these solutions. Implicit in this is a great quote from Richard Dawkins: "However many ways there may be of being alive, it is certain that there are vastly more ways of being dead"—there's a very finite number of ways to be alive, with each living species having converged on one of them.

## Chapter 7: A Primer on Emergent Complexity

1. Note to self: check to see if Versailles is made of bricks.
2. This concept was invoked by chess grand master Garry Kasparov in 1996 when he famously lost a match to IBM's chess-playing computer, Deep Blue. Referring to the sheer power of the computer, arising from its ability to evaluate two hundred million positions on the board per second, he explained, "What I discovered yesterday was that we are now seeing for the first time what happens when quantity becomes quality" (B. Weber, "In Kasparov vs. Computer, the Chess Scorecard Is 1-1," *New York Times*, February 12, 1996). This principle was first stated by Hegel and greatly influenced Marx.
3. Check out Ohio State's marching band doing the Michael Jackson shtick at [www.youtube.com/watch?v=RhVAga3GhNM](http://www.youtube.com/watch?v=RhVAga3GhNM).
4. Anderson gives a wonderful example of this idea, quoting an exchange between F. Scott Fitzgerald and Ernest Hemingway: "Fitzgerald: The rich

are different from us. Hemingway: Yes, they have more money. Everything else about rich-ness just emerges from that.”

5. Neurobiologist Robin Hiesinger, whose work will be covered later in the chapter, gives a wonderful example of this idea. You’re learning a piece on the piano, and you make a mistake and grind to a halt. Rather than being able to resume two measures earlier, akin to resuming on the highway, most of us need to let the complexity unfold again—we go back to the beginning of the section.
6. The early-twentieth-century essayist Lu Xun captured the essence of this, writing, “The world has no road at the beginning; once enough people walked on it, the road appeared” (Liquan Luo, personal communication).
7. For example, suppose you share a sequence of ten items, nine of which are roughly similar. There is one glaring exception, and your overall assessment of the properties of this sequence can change depending on whether randomness resulted in the exception being the second example you see or the tenth.
8. Crossing my t’s and dotting my i’s: As I noted, the traveling salesman problem is formally unsolvable, in that it is not possible mathematically to prove or disprove that a particular solution is the most optimal. This is closely related to what are called “minimal spanning tree problems,” where mathematical proofs are possible. The latter are relevant to things like telecommunication companies figuring out how to connect a bunch of transmission towers in a way that minimizes the total distance of cable needed.
9. The worm, called *Caenorhabditis elegans*, is beloved because every worm has exactly 302 neurons, wired up in the same way in every worm. It’s a dream for studying how neuronal circuits form.
10. This is a very abstract, dimensionless sort of “environment,” so that the likes of an ant leaving its nest to forage, a neuron extending a cable toward another one to form a connection, and someone doing an online search can be reduced to their similarities.
11. The information contained in the waggle dance was first fully decoded by Karl von Frisch early in the twentieth century; the work was seminal to the founding of the field of ethology and won von Frisch a Nobel Prize in Physiology or Medicine, to the utter bafflement of most scientists—what

do dancing bees have to do with physiology or medicine? A lot, as one point of this chapter.

12. Thus, colonies differ as to how evolutionarily “fit” they are at getting self-organized swarm intelligence just right. One paper exploring this has an -all-time best title in a science journal: “Honeybee Colonies Achieve Fitness through Dancing.” Presumably, this paper pops up regularly in Google searches for Zumba classes.
  
13. This approach isn’t perfect and can produce the wrong consensus decision. Ants living on a plain want a really good lookout from the top of a hill. There are two nearby hills, one twice the height of the other. Two scouts go out, each heads up their hill, and the one on the shorter hill gets there and starts broadcasting in half the time that it takes the loftier hill ant to start. Meaning it starts the recruitment doubling earlier than the other ant, and soon the colony has chosen . . . the shorter hill. In this case, the problem arises because the strength of the recruitment signal is inversely correlated with the quality of the resource. Sometimes a process can be completely out of whack. There are all sorts of cases of machine-learning algorithms that come up with a bizarre solution to a problem because the programmer underspecified the instructions, not informing it of all the things it was not allowed to do, what information it was not supposed to pay attention to, and so on. For example, one AI seemingly learned to diagnose melanomas but learned instead that lesions photographed with a ruler next to them are likely to be malignant. In another case, an algorithm was designed to evolve a simulated organism that was very fast; the AI simply grew an organism that was incredibly tall and thus reached high velocities when it would fling itself over. In another, the AI was supposed to design a Roomba that could move around without bumping into things—as assessed by its bumper being hit—and learned instead to simply stagger around leading with its back, where there was no bumper. For more examples, see: “Specification Gaming Examples in AI—Master List: Sheet1,” [docs.google.com/spreadsheets/d/e/2PACX-1vRPiprOaC3HsCf5Tuum8bRfzYUiKLRqJmbOoC-32JorNdfyTiRRsR7Ea5ezWtvsWzuxo8bjOxCG84dAg/pubhtml](https://docs.google.com/spreadsheets/d/e/2PACX-1vRPiprOaC3HsCf5Tuum8bRfzYUiKLRqJmbOoC-32JorNdfyTiRRsR7Ea5ezWtvsWzuxo8bjOxCG84dAg/pubhtml).
  
14. Pheromones are chemical signals released into the air—odorants—that carry information; in the case of ants, they have glands for this particular pheromone in their rears, which they dip down to the ground, leaving a trail of droplets of the stuff. So these virtual ants are leaving virtual pheromones. If there is a constant amount of pheromone in the gland at the beginning, the shorter the total walk, the thicker the amount of pheromone

that gets laid down per unit of distance.

15. This search algorithm was first proposed by the AI researcher Marco Dorigo in 1992, giving rise to “ant colony optimization” strategies, with virtual ants, in computer science. This is such a beautiful example of quantity producing quality; when I first grasped it, I felt dizzy with its elegance. And as a result, the quality of this approach is reflected in the loudness of my broadcasting about it—I drone on about this more frequently in lectures than about less cool subjects, making it more likely that my students will grasp it and tell their parents about it at Thanksgiving, increasing the odds that parents will tell neighbors, clergy, and elected representatives about it, leading to the optimized emergent behavior of everyone naming their next child Dorigo.

Note that, as stated, this is an ideal way to get close to the optimal solution. If you require the optimal solution, you’re going to need to brute-force it with a slow and expensive centralized comparator. Moreover, ants and bees obviously don’t follow these algorithms precisely, as individual differences and chance creep in.

16. As a dichotomy, in cellular slime mold species, the collective forms only temporarily; in plasmodial slime molds, it’s permanent.
17. Raising the question of when the optimized behavior of those ex-individual cells constitute “intelligence,” in the same way that the optimized function of vast numbers of neurons can constitute an intelligent person.
18. To *vastly* simplify things, the two growth cones have receptors on their surfaces for the attractant molecule. As those receptors fill up with the attractant, a different type of attractant molecule is released within the -growth-cone branch, forming a gradient down to the trunk that pulls the tubules toward that branch. More extracellular attractant broadcasting, by way of more receptors filled, and more of an intracellular broadcast signal recruiting tubules. As one complexity in real nervous systems, different target neurons might be secreting *different* attractant molecules, making it possible to be broadcasting qualitative as well as quantitative information. As another complexity, sometimes a growth cone has a specific address in mind for the neuron it wants to connect with. In contrast, sometimes there’s relative positional coding, where neuron A wants to connect with the target neuron that is adjacent to the target neuron that has connected up with the neuron next to neuron A. Implicit in all this is that the growth cones are

secreting signals that repulse each other, so that the scouts scout different areas. I thank my departmental colleagues Liqun Luo and Robin Hiesinger, two pioneer scouts in this field, for generous and helpful discussions about this topic.

19. As an aside, there are also horizontal connections within the same layer between different mini columns. This produces a thoroughly cool piece of circuitry. Consider a cortical mini column responding to light stimulating a small patch of retina. As just noted, the mini columns surrounding it respond to light stimulating patches on either side of that first patch. As a great circuitry trick, when a mini column is being stimulated, it uses its horizontal projections to silence the surrounding mini columns. Result? An image that is sharper around its edges, a phenomenon called lateral inhibition. This stuff is the best.
20. As each new neuron arrives at the scene, it forms its synapses in sequence, one at a time, which is a way for a neuron to keep track of whether it has made the desired number of synapses. Inevitably, among the various growth cones spreading outward, looking for dendritic targets to start forming a synapse, one growth cone will have more of a “seeding” growth factor than the others, just by chance. Lots of the seeding factor causes the growth cone to recruit even more of the seeding factor and to suppress the process in neighboring growth cones. This rich-get-richer scenario results in one synapse forming at a time.
21. Lest we get overly familiar, that’s Georg Cantor, nineteenth-century German mathematician; Helge von Koch, turn-of-the-century Swedish mathematician; and Karl Menger, twentieth-century Austrian American mathematician.
22. With it being likely that dendrites, blood vessels, and trees would differ as to how many multiples of the diameter branches grow before splitting.
23. Lurking in here is the need for a fourth rule, namely to know when to stop the bifurcating. With neurons, or the circulatory or pulmonary systems, it’s when cells reach their targets. With growing, branching trees . . . I don’t know.
24. Chapter 10 will cover where randomness comes into biology, in this case in the form of the Growth Stuff not splitting *exactly* in half (i.e., 50 percent of the molecules going each way) every time. Those small differences mean that there can be some variability tolerated in a bifurcating system; in

other words, the real world is messier than these beautiful, clear models. As emphasized by Hungarian biologist Aristid Lindenmayer, this is why everyone's brains (or neurons, or circulatory system . . .) look similar but are never identical (even in identical twins). This is symbolically represented by the asymmetry in the final drawing of the 1Z level (which wasn't what I planned, but which I messed up while drawing it).

25. One model is called a Turing mechanism, named after Alan Turing, one of the founders of computer science and the source of the Turing test and Turing machines. When he wasn't busy accomplishing all that, Turing generated the math showing how patterns (e.g., bifurcations in neurons, spots in leopards, stripes in zebras, fingerprints in us) can be generated emergently with a small number of simple rules. He first theorized about this in 1952; it then took a mere sixty years for biologists to prove that his model was correct.
26. A recent study has shown that two genes pretty much account for the branching pattern in Romanesco cauliflower. If you don't know what one of those looks like, stop reading right now and go Google a picture of it.
27. With historical events providing some of that instability. Think of Martin Luther getting fed up with the corruption of Rome, leading to the Catholic/Protestant schism; a disagreement as to whether Abu Bakr or Ali should be Muhammad's successor, resulting in Sunnis and Shi'ites going their separate Islamic ways; Central European Jews being allowed to assimilate into Christian society, in contrast to Eastern European Jews, giving rise to the former's more secular Reform Judaism.
28. A reminder, once again, that the real world of cells and bodies isn't as clean as these highly idealized models.
29. And there's an additional level of rules like these with different attractant and repellent signals that sculpt what *types* of neurons wind up in each cluster, rules like "Only two coffee shops per mall."
30. What are termed hydrophobic or hydrophilic amino acids—whether the amino acid is attracted to or repelled by water. I once heard a scientist mention in passing how she didn't like to swim, referring to herself as being hydrophobic.
31. Think biochemistry's equivalent of domes being most stable for the smallest cost when geodesic.

32. How do those various neurons know, say, *which* attractant or repellent signals to secrete and when to do it? Thanks to other emergent rules that came earlier, and earlier before that, and . . . turtles.
33. The study was fascinating. Some places were net exporters of intellectuals, places that they were more likely to move away from than move to—Liverpool, Glasgow, Odessa, Ireland, the Russian Empire, and my simple village of Brooklyn. This is the “please get me out of here” scenario. And then there are the net importers, magnets like Manhattan, Paris, Los Angeles, London, Rome. One of those magnets where intellectuals clustered, living out the rest of their (short) lives, was Auschwitz.
34. Bacon numbers show what the long tail of unlikelihood looks like in a -power-law distribution. There are approximately one hundred thousand actors with a Bacon number of 4 (84,615), about ten thousand with 5 (6,718), about one thousand with 6 (788), about one hundred with 7 (107), and eleven with a Bacon number of 8—with each step further out in the distribution, the event becomes roughly ten times rarer.

Mathematicians have “Erdős numbers,” named for the brilliant, eccentric mathematician Paul Erdős, who published 1,500+ papers with 504 collaborators; a low Erdős number is a point of pride among mathematicians. There is, of course, only one person with an Erdős number of 0 (i.e., Erdős); the most common Erdős number is 5 (with 87,760 mathematicians), with the frequency declining with a power-law distribution after that.

Get this—there are people with both a low Bacon number *and* a low Erdős number. The record, 3, is shared by two people. There’s Daniel Kleitman (who published with Erdős and appeared in the movie *Good Will Hunting* as an MIT mathematician, which is, well, what he is; Minnie Driver, with a Bacon number of 1, costarred). And there’s mathematician Bruce Reznick (also a 1-Erdős-er who, oddly, was an extra in what was apparently an appallingly bad movie, with a Rotten Tomatoes score of 8 percent, called *Pretty Maids All in A Row*, which included 1-Bacon-ist Roddy McDowall). As long as we’re at it, MIT mathematician John Urschel has a combined Flacco/Erdős number of 5, due to an Erdős number of 4 and a Flacco number of 1; Urschel played in the NFL alongside quarterback Joe Flacco, who apparently is/was extremely important.

35. Most, but not all, show this property. The exceptions are important,

showing that cases with the distribution were selected for, evolutionarily, rather than being just inevitable features of networks.

36. As an example of a generalist, the mutation in Huntington's disease produces an abnormal version of a particular protein. How does this explain the symptoms of the disease? Who knows. The protein interacts with more than *one hundred* other types of protein.
37. A contrast that has been framed as choosing between maximizing strength versus robustness, or maximizing evolvability versus flexibility, or maximizing stability versus maneuverability.
38. The brain contains "small-world networks," a particular type of power-law distribution that emphasizes the balance between optimizing the interconnected nature of clusters of functionally related nodes, on one hand, and optimizing the fewest average number of steps linking any given node to another.
39. Due diligence footnote: Not everyone is thrilled with the notion of the brain being chock-full of power-law distributions. For one thing, as some techniques improve for detecting thin axonal projections, many of the scant long-distance projections turn out to be less scant than expected. Next, there is a difference between power-law distributions and "truncated" - power-law distributions. And mathematically, other "heavy-tailed" distributions are incorrectly labeled as power-law ones in many cases. This is where I gave up on reading this stuff.
40. "Many more" including an emergent phenomenon called stigmergy, which, among other things, explains how termites move more than a quarter ton of soil to build thirty-foot-high mounds that do gas exchange like your lungs do; back-propagating neural networks that computer scientists copy in order to make machines that learn; wisdom-of-the-crowd emergence where a group of individuals with average expertise about something outperforms a single *extreme* expert; and bottom-up curation systems that, when utilized by Wikipedia, generate accuracy on the scale of the *Encyclopedia Britannica* (Wikipedia has become the major source of medical information used by doctors).
41. Which seems important, as the differences in patterns of genes expressed in these cells when comparing human brain organoids with those of other apes are really dramatic.



42. A number of labs now are making human brain organoids with neurons containing Neanderthal genes. Other research allows cortical organoids to communicate with organoids of muscle cells, making them contract. And another group has been making organoid/robot interfaces, each communicating with the other.

Okay, is it time to freak out? Are these things on their way to consciousness, feeling pain, dreams, aspirations, and love/hate feelings about us, their creators? As framed in the title of one relevant paper, time for a “reality check.” These are model systems of brains, rather than brains themselves (useful for understanding, say, why Zika virus causes massive structural abnormalities in human fetal brains); to give a sense of scale, organoids consist of a few thousand neurons, while insect brains range in the hundreds of thousands. Nonetheless, all this must give one pause (“Can Lab-Grown Brains Become Conscious?” asks another paper as its title), and legal scholars and bioethicists are starting to weigh in about what kinds of organoids might not be okay to make.

43. There’s a wonderful quote often used about emergence: “The locusts have no King, yet all of them march in rank.” I like the irony of this, since it’s found in a book that extols the putative individual who gains the most if the world runs on centralized top-down authority—it comes from the Old Testament (Proverbs 30:20). Oh, and by the way, why do locusts march? Each locust marches forward because the locust immediately behind is trying to eat it.

## Chapter 8: Does Your Free Will Just Emerge?

1. Jargon: they all have a “steroidal ring structure.”
2. For completeness: The top hormone in the left column is aldosterone. Starting at the top of the right column, the hormones are cortisol, a neurosteroid called pregnenolone, and progesterone.
3. Twentieth-century philosophy pretty much only considered the hypotheticals of strong emergence, and Bedau makes an eye-catching plea for why philosophers should become interested in weak emergence—because it’s how the real world actually works.

4. Brazilian philosopher Gilberto Gomes, defensively disavowing magic, writes that in his compatibilist viewpoint, “this I is not an abstract or supernatural entity outside the realm of natural causality. The I is a self-organizing and self-steering system.”
5. I.e., LSD.
6. Trick question.
7. This experimental approach alludes to classic research by Solomon Asch in the 1950s showing that an unnervingly large percentage of people will conform in particular settings to something they know is wrong (with the full range of what *wrong* can mean, ranging from “Which line is shortest?” to “Should these people be exterminated?”). Little surprise that this and other classic conformity and obedience studies were prompted by World War II: Did all those Germans actually believe that stuff, or were they just being team players?
8. Another fascinating example of macro influencing micro concerns something covered in chapter 3—on the average, people from individualist cultures look at the person in the center of a picture, while those from collectivist ones scan the entire scene. Reflect on this: Culture is as emergent as things get, influencing what foods are sacred, what kinds of sex are taboo, what counts as heroism or villainy in stories. And all this determines the microfunction of neurons that control your unconscious eye movements. Hmm, why’d you look at that part of the picture first? Because of my neuronal circuitry. Because of what happened to my people five centuries ago in the Battle of Wherever. Because . . .
9. Despite the fact that, to quote the architect Louis Kahn, “even a brick wants to be something.”

## Chapter 9: A Primer on Quantum Indeterminacy

1. In this case, a “particle” is anything from subatomic particles to atoms, molecules, and macroscopic things like dust motes.

2. These factors influencing Brownian motion are formalized in the Stokes--Einstein equation (named for Sir George Stokes, a viscosity savant who died shortly before Einstein burst on the scene). The numerator in the equation concerns the main force that increases motion, namely temperature; the denominator concerns the forces countering the particles, namely high viscosity of the surrounding environment and large average size of particles.
3. Which is why identical twins, with identical genes, don't have identical cells even when each twin consists of just two cells, with the differences magnifying up from there. This is part of why identical twins aren't identical people with brains supposedly sculpted identically by their identical genes.
4. With the movement pattern showing a power-law distribution. Back to chapter 7—around 80 percent of foraging forays are within 20 percent of the maximal foraging distance.
5. In the small-world category, one of the contributors to this topic, favoring a free-will stance for both humans and other animals, is neurobiologist Martin Heisenberg. Yes, son of Werner Heisenberg. Apparently, the tree freely wills an apple to drop locally.
6. And note here how the New Age interpretation has just jumped from considering the consequences of the formal process of “measurement” to the highly personal process of “observing.”
7. Which has not only caught the public's imagination but also generated endless Heisenberg uncertainty jokes (Heisenberg, speeding down the freeway, is stopped by a cop. “Do you know how fast you were going?” the cop asks. “No, but I know where I am,” Heisenberg replies. “You were driving eighty miles per hour,” says the cop. “Oh, great,” says Heisenberg, “now I'm lost.”).
8. Bohr also supplied one of my favorite quotes about the scientific venture: “The opposite of fact is falsehood, but the opposite of one profound truth may very well be another profound truth.”
9. I thank physicist Sean Carroll for guiding me through much of this. By the way, research on entanglement was the basis of the 2022 Nobel Prize in Physics, awarded to John Clauser, Alain Aspect, and Anton Zeilinger.

10. Implicit in this is that you can experimentally induce entanglement in two particles, which seems to involve pointing lasers at things.
11. Or at least way faster than the experimental limits of time resolution, on the scale of quadrillionths of a second. Which is at least nine orders of magnitude faster than the speed of light. By the way, if I understand things correctly, superposition of a single particle can be thought of as involving -entanglement—an electron is entangled with itself as it passes through two slits at the same time.
12. In 1905, Einstein was the most glamorous, dashing revolutionary since Che (if time flows backward). As he aged, though, Einstein led some rearguard reactions against subsequent physics revolutions. This is a familiar pattern with many revolutionary thinkers. The psychologist Dean Simonton has shown that this closing to novel ideas is a function not so much of someone's chronological age as of their disciplinary age—it's being acclaimed in a particular field for a long time (after all, all anything new and revolutionary can do is knock you and your buddies out of the textbooks). Years ago, I did a quasiscientific study (published in that esteemed technical journal *The New Yorker*), showing the ways in which most people, acclaimed thinkers or otherwise, close to novelty in music, food, and fashion as they age. Learning of Einstein as an aged counterrevolutionary disappointed all of us who had the obligatory poster of him sticking out his tongue on our dorm room walls.
13. The study is controversial, though, as some scientists suggest nonentanglement mechanisms as explanations. The study involved bacteria that were placed between two mirrors that were less than a hair's width apart. And the phenomenon was demonstrated in *six* individual bacteria. One is accustomed to things like "neuroimaging was carried out on six adults carrying the mutation" or "epidemiological surveys were carried out in six countries." A study using six bacteria seems charming and commensurate with all this weirdness. But given this tiny number of bacteria, one has to ask questions like what each one had eaten that morning; when they were fetuses, whether their moms had regular wellness checks; what kind of culture these bacteria's ancestors grew up in.

## Chapter 10: Is Your Free Will Random?

1. Interestingly, I've seen none of the same done with the indeterminacy of Brownian motion—for example, no one is making a bundle running Brownian transcendence seminars. This isn't surprising—quantum indeterminacy is about being in multiple places at once, while Brownian motion is about dust particles being random. Thus, I suspect that New Agers view Brownian motion as dead-White-male-ish, like union guys who nonetheless vote Republican, while quantum indeterminacy is about love, peace, and multiple orgasms. (This pretty picture is complicated by the fact that quantum patriarch Werner Heisenberg labored to make an atomic bomb for the Nazis. Historians are divided as to whether Heisenberg's postwar claim that the bomb didn't happen because he was quietly sabotaging the effort is a redemptive truth or Heisenberg covering his ass.)
2. By the way, the quote at the beginning of this section, "Attention and intention are the mechanics of manifestation," was made by someone named Tom Williamson who randomly strings together words from Deepak Chopra's Twitter stream. Two of today's random fictional Chopra quotes at Williamson's site ([wisdomofchopra.com](http://wisdomofchopra.com)) are "A formless void is inside the barrier of facts" and "Intuition reflects your own molecules." The site is discussed in an irresistibly interesting paper by psychologist Gordon Pennycook, entitled "On the Reception and Detection of Pseudo-profound Bullshit."
3. That said, some experts, such as philosopher of physics J. T. Ismael of Columbia University, view free will as the product of classical physics.
4. In the Broadway musical version (but *not* the movie, I say with inexplicable bitterness), Mary empowers Jane and Michael by singing, "Anything can happen if you let it," a view about exercising free will to prevent exercising unwanted free won't. The song then makes Broadway musical history by rhyming *marvel* ("anything can happen, it's a marvel") with *larval* (Michael: "You can be a butterfly," Jane: "Or just stay larval"). It took decades for Idina Menzel to top this, singing about fractals in "Let It Go."
5. Eccles is usually framed as a sad tale of the ravages of time, a pitiable octogenarian scientist suddenly proclaiming that the brain runs on invisible star stuff. In reality, Eccles was already heading in this direction in his late forties.

6. This is as far as I could get myself to go with Google Translate, as it's in German.
7. This is an overestimate, since you're not using every hippocampal neuron at the same time. Still, it's in this ballpark.
8. Physicist Sean Carroll emphasizes this dichotomy, noting how in the nonclassical micro world, there is no arrow of time; the only difference between the past and the future is that one is easier to explain and the other is easier to influence, and neither interests the universe. It is only at the macro level of classical physics that our usual sense of time becomes meaningful.
9. For Hameroff, this spatial nonlocality (i.e., how, say, one molecule of neurotransmitter can be interacting with a smear of receptors at once) is accompanied by temporal nonlocality. Back to Libet and chapter 2, where neurons commit to activating muscles before the person consciously believes they have made that decision. But there's an end-around for Hameroff. Quantum phenomena "can cause temporal non-locality, sending quantum information *backward in classical time*, enabling conscious control of behavior" (my italics).
10. Which is glacial from the standpoint of the nervous system—an action potential takes a few thousandths of a second.
11. "Much rarer." If there was spontaneous release of a single vesicle from an axon terminal an average of once every one hundred seconds, then the probability of two being released simultaneously was once every ten thousand seconds (as in  $100 \times 100 = 10,000$ ). Three at once? Once every one million seconds. Katz was sitting there for a long time to notice all this.
12. I'm forced here to use a term that I have desperately tried to avoid in the main text, because of the confusion it would sow. The phenomenon of neurotransmitter being released in irreducible-size little packets is known as "quantal" release. I'm not going anywhere near why *quantal* and *quantum* have the same roots.
13. As noted earlier, my wife is a musical theater director in a school, which is why this scenario comes to mind. And despite expectations, the outcome is never random—in a pattern well known in psychology circles, the ensemble members are most likely to shout out the first or last options in

the list, or the one that is most fun to say (e.g., “Yippee!”), particularly loudly. Then there’s the rare kid who shouts something like “Elmo!” or “Tofu!” and who is destined for greatness and/or sociopathy.

14. Yeah, it’s mid-2020, and we just discovered that the car’s battery is dead, three months now into the pandemic lockdown.
15. If you insist: about twenty millivolts for the former, half a millivolt for the latter.
16. And now we can’t find our AAA card for when the tow truck gets here.
17. Searle, a particularly clear thinker and writer, attacks the implausibility of a dualism that separates self, mind, consciousness, from the underlying biology, sarcastically asking whether, in a restaurant, it would make sense to say to the waiter, “Look, I am a determinist—*que será será*, I’ll just wait and see what I order.” What is the problem of free will in neurobiology? According to Searle, it’s not whether it exists, independent of underlying -biology—it doesn’t. For him, the philosophical “solution kicks the problem upstairs to neurobiology.” For him, the problem is why we have such strong illusions of free will, and whether that is a good thing. Definitely not, but we’ll get to that near the end of the book.
18. In addition to randomness being a pretty implausible building block for free will, it turns out that it is extremely hard for people to actually produce randomness. Ask people to randomly generate a sequence of ones and zeros, and inevitably, a significant degree of patterning slips in.
19. As an aside that might just be mighty relevant to a book about behavior and responsibility, Searle presents an example of those challenges of integrating dramatic inconsistencies into a coherent whole. He was a renowned philosopher at UC Berkeley, with honorary degrees out the wazoo and a philosophy center named for him. Sociopolitically, he was on the side of angels—as an undergrad at University of Wisconsin in the 1950s, he organized student protests against Wisconsin senator Joe McCarthy, and in the 1960s, he was the first tenured Berkeley professor to join the Free Speech Movement. Admittedly, in his later years, his progressive politics gave way to neoconservatism, but that’s the trajectory of many an aging ex-leftist. But most important, in 2017, the then-eighty-four-year-old Searle, with so much to say about moral philosophy, was accused of sexual assault by a research assistant, and following that, a career’s worth of allegations of harassment, assault, and sexual quid pro

quos with students and staff came to light. Allegations that the university concluded were credible. Thus, moral philosophizing and moral behavior aren't synonymous.

20. Dennett is not necessarily tying his wagon to quantum indeterminacy in this scenario; this is merely a clear description of what harnessing random indeterminacy might look like.
21. With Roskies and Shadlen defining "policies" as meaning "constitution, temperament, values, interests, passions, capacities, and so forth."
22. People often frame this in the context of the infinite monkey theorem, the thought experiment where an infinite number of monkeys typing for an infinite length of time eventually produce all of Shakespeare. A feature of the thought experiment explored by many computer scientists is how to most efficiently check which of the infinitely large number of massive manuscripts generated fits the Bard down to each comma. This is hard work because among the manuscripts produced will be a zillion that perfectly reproduce Shakespeare until the last page of his final play, until veering off into unique gibberish. One experiment used virtual monkeys typing; after over a billion monkey years (how long is a monkey year of typing?), one monkey typed, "VALENTINE. Cease toIdor:eFLP0FRjWK78aXzVOwm)-';8.t . . . ,." The first nineteen letters occur in *The Two Gentlemen of Verona*; this holds the record for the longest Shakespearean quote by a virtual monkey. Finding algorithms that efficiently filter out the non-Shakespeare from the Shakespeare is often called Dawkins' weasel (after Richard Dawkins [author of *The Blind Watchmaker*], who proposed sorting algorithms in the context of the generation of random variation in evolution. This name represents a merciful reduction in the task for the monkeys, who now merely must type one sentence from *Hamlet*. Hamlet points out a cloud to Polonius that is shaped like a camel. "Yeah, looks like a camel to me," says Polonius. "Methinks it is like a weasel," opines Hamlet, questioning the notion of shared reality while throwing down the gauntlet to the monkey typists.

Footnote about a footnote: Killjoys have suggested that even if a monkey typed all of *Hamlet*, it wouldn't be *Hamlet*, because the monkey hadn't intended to type *Hamlet*, didn't understand Elizabethan culture, and so on. This seems immensely cool to think about, with relevance to Turing machines and artificial intelligence. Borges wrote a wonderful story, "Pierre Menard, Author of the Quixote," about a twentieth-century writer who attempts to so completely immerse himself in seventeenth-century Spanish



life that when he re-creates the manuscript of *Don Quixote*, generates it on his own, it will not be a plagiarized copy of Cervantes's *Don Quixote*. Instead, despite the word-for-word similarity, it will actually be Menard's *Don Quixote*. The story is funny as hell and illustrates why there will never be a Chim-Chim's *The Tragedy of Hamlet, Prince of Denmark*.

Okay, another footnote about a footnote: If you search “infinite monkey theorem” on Google Images, about 90 percent of the primates pictured are chimps, who are *apes*, not monkeys. Pisses me off. Some good cartoons, though, about “monkeys” typing sonnets about bananas.

23. Note that he is using the less common meaning of *realized*, as something coming into being.
24. Searle gives a particularly clear explication of why the idea of top-down harnessing of randomness to create free will is silly. J. Searle, “Philosophy of Free Will,” Closer to Truth, September 19, 2020, YouTube video, 10:58, [youtube.com/watch?v=973akk1q5Ws&list=PLFJr3pJI27pIqOCeXUnhSXsPTcnzJMAbT&index=14](https://www.youtube.com/watch?v=973akk1q5Ws&list=PLFJr3pJI27pIqOCeXUnhSXsPTcnzJMAbT&index=14).
25. “Legendary,” as in everyone attributes that to Feynman, but I couldn't find an exact source, other than “in one of his [famed] lectures.”

## Chapter 10.5: Interlude

1. Both monkeys and chimps interact differently with a person who is unable to give them food, versus one who is able but unwilling; they don't want to be around the latter: “What a mean hairless primate—they could have given me food but *chose* not to.” Particularly interesting work, by psychologist Laurie Santos of Yale, has shown that other primates have their own sense of agency. A human test subject rates their preferences for an array of household items. Find two that are rated equivalently, and force the person to choose one over the other; thereafter, they show a preference for that item: “Hmm, I'm a rational agent of free will, and if I chose this one over that one, it must have been for a good reason.” Do the same thing with capuchin monkeys—force them to choose one of two different colored M&M's, have them *believe* that they made a choice (even under circumstances where, unknown to them, their choice is actually forced)—and they show a preference for that color thereafter. If a human chooses for them, no preference emerges.

2. Leopold and Loeb. Not to be confused with Lerner and Loewe.
3. Jeremy Meeks, the famed “hot felon.”

## Chapter 11: Will We Run Amok?

1. Variants on the manipulations: Reading single sentences saying things like “Scientists believe that free will is . . .” versus “Scientists believe that free will is not . . .” Having to write a summary of the Crickian (or control) reading. Being asked to recount a time when they exercised a great deal of free will or when they had none.
2. Vohs’s work has been extremely influential and widely cited.
3. The implicit binding phenomenon has some elaborations. In one study, the button was pressed by another individual; subjects typically underestimated the interval between the pressing and the subsequent tone, showing that they were projecting agency onto the other person . . . unless they thought the timing of the button press was determined by a computer rather than a human.
4. Which, it should be noted, suggests that even if you decrease free-will belief a smidgen, people who nonetheless still believe overall in free will become more amok-ish. Not great news.
5. On a related note, throwing some Crick at judges lessens their free-will - belief . . . without changing their judgments. Why am I bothering writing this book?
6. Is this because of that depressogenic void left by a lack of a god? Perhaps in part, but the minority status probably plays a role as well—in markedly secular Scandinavian countries, it is the minority who are highly religious who have higher rates of depression.
7. Necrophilia *and* bestiality—come on, really? This atheist is finally getting a bit fed up with this.
8. This antiatheist bias runs alongside a widespread belief that being a

scientist precludes being moral (amid scientists generally being respected and viewed as “normal” in degree of caring, trustworthiness, or valuing fairness, and not particularly prone toward atheism). Instead, scientists are viewed as being immoral in realms of loyalty, purity, and obedience to authority. One reason makes sense to me, amid its nearly always being - wrong—that in the pursuit of scientific findings, scientists would not hesitate to do things that would be considered immoral by some people (e.g., vivisection, human experimentation, fetal tissue research). The second reason kind of floors me—that scientists would be willing to undermine moral norms by promulgating something, just because it happens to be . . . true.

9. A similar challenge hobbles the literature showing that religious belief seems to have some health benefits: “You, yeah you, you start believing. You, over there, you don’t. Let’s meet in twenty years and check your cholesterol levels.”
10. There is, of course, similar if less studied heterogeneity to styles of -atheism—people who mostly arrived at their stance analytically versus emotionally, people raised with belief who seceded versus those who were never believers, people whose stance is an active versus a passive one (stay tuned for the end of this chapter), gradually acquired versus arising from a non-Zeusian bolt of lightning. Amid that heterogeneity, though, most atheists seem to have gotten to where they are by an analytic route (not me, though), and when people are experimentally prompted to think more analytically, they also then report less religious belief. And then there are atheists who, nonetheless, embrace some religion’s culture and rituals or embrace the stable supportiveness of a humanistic community of nonbelievers, versus those doing their atheism in a solitary way. All this brings to mind the argument in *Catch-22* between Yossarian and Mrs. Scheisskopf, both atheists, about the nature of the God they don’t believe in. The bitter Yossarian wishes there were a God so that he could express the violence and hatred he feels toward Him for His divine cruelty; Mrs. Scheisskopf is horrified by this blasphemy, insisting that the God she doesn’t believe in is warm, loving, and benevolent.
11. An interesting parallel occurs with the notion that during times of trouble, atheists lack the larger structures of comfort available to theists. In reality, at such times, many atheists resort to and gain comfort from their belief in science.
12. It should be noted that while Scandinavian governments expend more

money on the poor than does the U.S., Scandinavian people give individually to charities at a lower rate than Americans; however, the higher rates of governmental social services in Scandinavia more than offset the higher rates of charitability in the U.S. The distinctive cultural responses to tragedy in one Scandinavian country will be explored in chapter 14.

13. Okay, despite my obvious enthusiasm, it is crucial to point out how Scandinavian countries have gotten a ton of egalitarian mileage out of being small, ethnically/linguistically homogeneous countries, and more American-esque problems are emerging as they become less so. And then there's ABBA.
14. Just as an important reminder from chapter 3, genes don't determine your future; instead, they work in different ways in different environments. Nonetheless, a stance of "It's all genetic" is an acceptable stand-in in this case for "It's all biological."
15. To paraphrase Henry Ward Beecher.
16. To paraphrase Tevye.
17. To paraphrase comedian Ricky Gervais (as cited by, hmm, psychologist Will Gervais).

## Chapter 12: The Ancient Gears within Us: How Does Change Happen?

1. The SN-Exc-MN route works a little slower than the SN-MN, since the SN-MN signal needs to traverse only one synapse, while SN-Exc-MN involves two.
2. Just as a reminder, all the DNA is in a single, continuous stretch, rather than broken into separate parts; the DNA was drawn this way for clarity; also, I don't know why the DNA gets smaller toward the right in my drawing, but it's not like that in real life.
3. Two subtleties. First, after all that effort to construct that second synapse, why not just keep it around, assuming that it will be useful at some point in

the future for dealing with another cluster of high-intensity shocks? Because maintaining a synapse is expensive—repairing wear-and-tear damage to proteins there, replacing them with new models, paying rent, the electric bill, etc. And here there’s been an econometric evolutionary trade-off for *Aplysia*—if there are going to frequently be shockful circumstances where the *Aplysia* will need to retract its gill ten times longer than normal, might as well retain that second synapse; in contrast, if it’s a rare event, it’s more economical to degrade the second synapse, and just make another one of it somewhere in the distant future when needed. This is a common issue in physiological systems, having to choose between keeping an emergency system on all the time versus making it inducible as a function of the frequency of emergencies. For example, should a plant expend energy making a costly toxin in its leaves to poison an herbivore munching on it? - Depends—is it some sheep coming to graze every day or a cicada coming once every seventeen years?

An even subtler issue: Suppose the tail has been shocked once, and a smidgen of Stuff is liberated inside the SN. How does that small number of Stuff molecules “know” to activate step #1 rather than #2 or #3? Why that hierarchy? The way it is solved is a common theme in biological systems: The molecules that are triggered by Stuff in the step #1 pathway are much more sensitive to Stuff than the relevant molecules in the step #2 pathway, which in turn are more sensitive than those in step #3. Thus, it’s like a layered fountain: it takes X amount of Stuff to activate #1; more-than-X to spill over and also start activating #2; lots-more-than-X to spill over into #3 as well.

4. Just to inundate you more, here’s what the abbreviations are for: 5HT = serotonin; cAMP = cyclic adenosine monophosphate; PKA = protein kinase A; CREB = cAMP response element-binding protein; MAPK = -mitogen-activated protein kinase; C/EBP = CCAAT-enhancer-binding protein. On and on.
5. And the more new synapses, the stronger the conditioning.
6. And implicit in this is that we and *Aplysia* share the genes that code for cAMP, PKA, MAPK, and so on. In fact, we share at least half our genes. To give a sense of just how pervasive this overlap is, we share roughly 70 percent of our genes with sponges—and they don’t even have neurons.
7. Just to be clear, the circuit is more complex than in the figure, and this has forced me to look up all sorts of obscure places in the brain in a

neuroanatomy textbook that I open once a decade. Neuron 1, which signals the air puff, is actually a sequence of three classes of neurons—first neurons in the trigeminal nerve, which stimulate neurons in the trigeminal nucleus, which stimulate neurons in the inferior olivary nucleus. Neuron 2, which turns the air-puff signal into an eyeblink, is also actually a sequence of three classes of neurons—the first being neurons in the interpositus nucleus within the cerebellum, which activate neurons in the red nucleus, which activate facial nerve neurons in the facial nucleus, which cause the eyeblink. Neuron 3 is also a series of neurons in real life, starting with the neurons of the auditory nerve, which stimulate neurons in the vestibulocochlear nucleus, which stimulate neurons in the pontine nucleus. Logically, projections from the inferior olivary nucleus (carrying air-puff information) and the pontine nuclei (carrying tone information) converge on the interpositus nucleus. Neurons 4 and 5 are a circuit in the cerebellum involving granule cells, Golgi cells, basket cells, stellate cells, and Purkinje cells. There, I’ve done my neuroanatomical duty and have already forgotten what I wrote three sentences ago.

8. How glucocorticoids disrupt the function of neurons like those in the interpositus is understood as well but is more detail than we need.
9. As far as I know, no one has seen if adult humans who underwent a lot of childhood adversity have impaired eyeblink conditioning, but it seems perfectly plausible. Which would obviously be the least of their long list of life-altering problems.
10. We’ve unpacked the features of fear conditioning: acquisition of the response (acquiring the conditioned response in the first place); consolidation of the response (remembering it long afterward); extinction of the response (gradually losing the response after being exposed to the tone a bunch of times where it *isn’t* followed by a shock).
11. According to historical records, current events, and the thread of *See alsos*, starting with the Wikipedia page “Ethnic and national stereotypes”: 1d, 2a, 3g, 4i, 5b, 6f, 7e, 8c, 9h.
12. Interestingly, this turns out to be a significant predictor of growing up to believe that COVID-19 vaccines are part of a conspiracy to harm you.
13. Just for clarification, there is actually little reason to think this was a circumstance where a lot of people were indeed conditioned to make this association solely as a result of that single statement. Instead, much of its

success was in signaling the people who already thought this way that Trump was their kind of guy. So this is just a simple model system of the reality, which requires repetition.

14. I'm apparently easily distractible right now, since, while looking for a good angel/devil image, I wound up looking at two hundred such pictures to confirm a spur-of-the-moment hypothesis that a disproportionate percentage of the images have the devil on the left shoulder and the angel on the right. And that was the case 62 percent of the time in my sample. As a leftie, I'm slightly offended—I've come to terms with being gauche, but being satanic is another thing.
15. The Mirabal sisters, Patria, Minerva, and Maria Teresa, were murdered in 1960 for their political opposition to the dictator of the Dominican Republic, Rafael Trujillo. An extra level of poignancy is added by the fact that there was a fourth sister, Dede, who was relatively apolitical and escaped death and who lived another fifty-four years without her sisters. Our household got obsessed with the Mirabals awhile back when one of our kids read a book about them.
16. Imagine a teenager, off at her freshman year of college. During that first semester, her friends begin to notice with concern that she isn't eating - much—she's always insisting that she feels full halfway through dinner, or that she feels a bit unwell and has no appetite. She'll even fast two, three days at a time; on more than one occasion, her roommate catches her forcing herself to throw up after a meal. When told by friends that she is becoming too thin, needs to eat more, she insists instead that she has a huge appetite, eats like a glutton, feels like that is a personal shortcoming to be - overcome—that's why she fasts. She's constantly talking about food, writing about it in letters home. While she has many female friendships, she seems to recoil from men—she says she plans to be a virgin her whole life, says that fasting is actually helpful to her in that it takes her mind off any sexual feelings. She's long since stopped menstruating, and her reproductive axis has shut down from starvation.

We know exactly what that is—anorexia nervosa, a life-threatening disease that is often interpreted in the context of our Westernized lifestyle as lying at the intersection of our overabundance of food and lives filled with interest in food consumption (*Iron Chef*, anyone?) on the one hand, and on the other, the corrosive, nonstop sexualizing of women in the media, which drives so many women and girls into body image problems.

Makes sense. But consider Catherine of Siena, born in 1347 in Italy. As an adolescent, and to her parents' consternation, she started limiting her food intake, always insisting that she was full or feeling infirm. She started having frequent, multiday fasts. Joining the Dominican Order of the church, she took a vow of celibacy; now married to Christ, she reported a vision in which she wore Christ's wedding ring . . . made from his foreskin. She would force herself to throw up when she felt she had eaten too much, explained her fasting as a display of her devotion and as a means to curb and punish herself for her "gluttony" and "lust." Her writings are full of imagery of eating—drinking the blood of Christ, eating his body, nursing from his nipples. Eventually, she got to a point where (wait for it . . .) she committed herself to eating only the scabs of lepers and drinking their pus, and wrote, "Never in my life have I tasted any food or drink sweeter or more exquisite [than pus]." She starved to death at thirty-three and was canonized in the next century, and her mummified head is on display in a basilica in Siena. An irresistible history. I even teach about her in one of my classes; the details about pus and scabs are always a crowd-pleaser.

## Chapter 13: We Really Have Done This Before

1. And remember, "being changed" by the circumstance of plowing through this book can consist not only of rejecting free will but also of deciding that all this is a crock and you now believe even more strongly in free will than before, or that this is the most boring topic imaginable.
2. Which are chambers deep inside the brain filled with cerebrospinal fluid.
3. Where are all these factoids from? From my having plowed my way through what is apparently the definitive book on the subject, a five--hundred-page bruiser by the Johns Hopkins physician and historian Owsei Temkin (*The Falling Sickness: A History of Epilepsy from the Greeks to the Beginnings of Modern Neurology*, first ed. 1945). It's one of those learned books with quotes in all sorts of ancient languages ("as Menecrates of Syracuse wryly observed . . .") that are not translated because, well, after all, who needs their Greek or Latin or Aramaic translated? One of those books where, if you're bored out of your mind by hundreds of pages of minutiae, you feel like it's your fault for being a Philistine, and not even an



interesting enough Philistine for Temkin to quote in whatever language they spoke.

4. Actually, Jesus gets kind of snarky about there even being a question of whether he has this under control. Can you cure my son? “You unbelieving generation. How long shall I stay with you? How long shall I put up with you? Bring the boy to me” (Mark 9:19, New International Version).
5. Depending on the edition, a “demon” or “vile spirit” or “impure spirit” or “foul spirit.”
6. The book demonstrates the fallacy of the myth that technological advances are intrinsically progressive. In the words of historian Jeffrey Russell of the University of California at Santa Barbara, “The swift propagation of the witch hysteria by the press was the first evidence that Gutenberg had not liberated man from original sin.”
7. Cesare Lombroso, the nineteenth-century inventor of “anthropological criminality,” which labeled criminality as innate, gained fame for discerning the facial features that supposedly identified someone as a once or future criminal; he perceived the same facial features in people with epilepsy.
8. And placed in a workhouse, which I guess counted as a marginal improvement over a prison then.
9. Falret came with quite the psychiatry pedigree. His father, Jean-Pierre Falret, was the first to accurately describe and label as a distinct disorder what we would now call bipolar disorder and what he called “circular insanity”—the cycling between manic and depressive phases. Fun fact about Jules—not only did he eventually inherit the mental institution that his father had founded, but he was born in the place, which I suppose counts in psychiatry as being born with a silver spoon in your mouth.
10. Often an indication of a brain tumor.
11. And such a hypothetical mob would most certainly define the person by their disease, burning the “epileptic’s license,” rather than “the license of the person suffering from epilepsy.”
12. One of whom was pregnant, and miscarried.

13. Why should anyone in their right mind ever skip their antiseizure medication, even if they are not driving or doing anything else dangerous? Simple. The drugs have substantial side effects that include sedation, slurring of speech, double vision, hyperactivity, sleep disturbances, mood changes, gum dysplasia, nausea, and rash. Taking the meds while pregnant increases the chances of your child having a cleft palate, heart abnormalities, spinal tube defects such as spina bifida, and something with a lot of similarities to fetal alcohol syndrome (according to the Epilepsy Society of the UK and the Epilepsy Foundation of Greater Chicago). Oh, and taking the drugs impairs cognitive function on every neuropsychological test you can throw at the topic. Little surprise, then, that the adherence rate to medications ranges roughly from 75 percent down to 25 percent.
14. And now the usual: “Great, so you’re advocating letting people just drive even if they haven’t taken their meds?” Not at all, as will be covered in the next chapter.
15. A genetic cousin of schizophrenia, a personality style (note, not a disease) called schizotypalism, is indeed historically associated with shamanism.
16. Consider the alternative medicine guru Andrew Weil, MD: “Psychotics are persons whose nonordinary experience is exceptionally strong. . . . Every psychotic is a potential sage or healer. . . . I am almost tempted to call psychotics the evolutionary vanguard of our species.”
17. The schizophrenia-is-groovy hidden-blessings movement was embedded in a larger one that questioned the existence of mental illness at all. This was often prompted by some of the horrendous corners of psychiatry’s history, with abuse of many patients, psychiatrists occasionally being the willing collaborators with totalitarians, the unequal domination and coercion in the very notion of child psychiatry, and so on. A leader of this antipsychiatry movement was, ironically, a psychiatrist himself, Thomas Szasz, who laid out his arguments in his 1961 *The Myth of Mental Illness* (Harper Collins). There was a cousin of this school of thought that took the form of “Psychiatry can’t even tell the difference between sane and insane people.” This got meteoric fame with the publication in *Science* in 1973 of the paper “On Being Sane in Insane Places” by Stanford psychologist David Rosenhan. It described a study he had overseen in which psychiatrically healthy collaborators went to psychiatric hospitals, pretending to be hearing voices. All were diagnosed as having schizophrenia and were admitted to the hospital, at which point the pseudopatients were to act perfectly normally

and report no more hallucinations. Despite this normal behavior, all were heavily medicated for months; a number were lobotomized and subjected to electroshock therapy; two of the pseudopatients were killed and cannibalized by staff psychiatrists who operated a child trafficking ring out of a DC pizzeria. At least, that approaches some of the urban legends that grew around that study as a result of the massive media coverage and miscoverage. In reality, what actually happened strikes me as perfectly - reasonable—the pseudopatients arrived feigning the symptoms of schizophrenia, they were admitted for observation, and thereafter the medical staff were perfectly capable of perceiving that there was then nothing abnormal in their behavior; most of the pseudopatients were released with a diagnosis of “schizophrenia in remission,” which means “Well, they came in reporting symptoms of schizophrenia, but we found nothing wrong with them while they were in the hospital.” As a postscript, investigative journalist Susannah Cahalan, in her 2019 book about Rosenhan, convincingly shows that he conveniently threw out data and subjects whose results did not fit the hypothesis, and might even have invented the existence of some of the pseudopatients—hence the double meaning of the title of the book—*The Great Pretender*. My sense from Stanford psychology colleagues who overlapped with Rosenhan is that few would argue strenuously against these allegations.

18. Hinckley was given a variety of psychiatric diagnoses by experts who examined him for both the prosecution and the defense, but the modal diagnosis, including from the doctors who have treated him in a psychiatric hospital for decades since, is that he was suffering from some sort of psychosis at the time of the shooting.
19. Amid populations of people with schizophrenia having somewhat higher rates of violence than average, they have hugely higher rates of being *victims* of violence.
20. Ironically, Freud despised Americans and rued the fact that the majority of his book royalties came from this land of barbarians. “Is it not sad that we are materially dependent on these savages who are not better-class human beings?” Part of his contempt for America was for its supposed tolerance of the menace of the “black race,” its egalitarian ethos, and equality between the sexes.
21. To quote the sociologist Laurence Peter (of the Peter principle), “Psychiatry enables us to correct our faults by confessing our parents’ shortcomings.” It’s also encapsulated in a joke: “My God, I had dinner

with my parents last night and I made the worst Freudian slip. I meant to say, 'Could you pass the salt, Dad?' and instead I said, 'You ruined my life, you bastard.'"

22. Who was somewhat briefly married to Margaret Mead, who was a major force in making anthropology a branch of Freudian thinking.
23. In addition, unexpectedly, another genetic problem in the disease involves perfectly normal genes having been abnormally duplicated into multiple copies.
24. As an aside, *Toxo* has a variety of fascinating effects on the brain, sufficiently so that part of my lab devoted a decade to studying it.
25. Just to make things even more fascinating, the majority of congenitally deaf individuals with schizophrenia actually report auditory hallucinations—i.e., hearing voices. How can someone who has never heard hear voices? The conclusion of most in that field is that that doesn't actually occur, and it is the person instead trying to impose meaning on their strange, disordered perception and lighting upon that mysterious concept of "hearing" that those hearing people are always going on about.
26. Another approach, which implicitly depends on schizophrenia being a disease of genetic vulnerability, has been to show that some subtler versions of the structural abnormalities are found in unaffected relatives of those with the disease.
27. A detail for neuroscience fans: Axons are "myelinated," wrapped in an insulating sheath made of cells called glia. It speeds up neuronal communication for reasons that I manage to teach confusingly in a class of mine year after year. The wrapping is fatty and whitish in color, and as a result, parts of the brain mostly made up of myelinated cables are termed "white matter," while areas packed with the unmyelinated cell bodies of neurons are termed "gray matter." White-matter freeways connecting gray-matter city centers, straight out of chapter 7's neuronal urban planning. So logically, the loss of axons in the cortex in the disease is accompanied by a reduction in white matter.
28. There are other brain changes as well, particularly atrophy of the hippocampus, a brain region central to learning and memory. There also seem to be abnormalities in the layering of hippocampal neurons. The near consensus in the field is that the structural changes in the frontal cortex are

the most important.

29. There's a problem lurking here that is subtle and cool, in an abstract sort of way (but definitely not in real life). So, in schizophrenia, there appears to be an excess of dopamine in parts of the brain related to logical thought, and a key treatment is to throw in a drug that blocks dopamine signaling. Meanwhile, Parkinson's disease is a neurological disorder in which sufferers have trouble initiating movement, where the core problem is a *loss* of dopamine in a completely different part of the brain, and a key treatment is to give people a drug (most often L-DOPA) that will *boost* dopamine signaling. You don't inject any of these drugs directly into the relevant brain region. Instead, you take the drug systemically (e.g., by mouth or by injection), which means it gets into the bloodstream and has its effect all over the brain. Give someone with schizophrenia a dopamine receptor blocker, and you decrease the abnormally high levels of dopaminergic signaling in the "schizophrenic" part of the brain back to normal; but at the same time, you decrease the *normal* levels elsewhere to below normal. Give L-DOPA to someone with Parkinson's, and you *raise* dopamine signaling in the "Parkinsonian" part of the brain to normal but *boost* signaling to above-normal levels elsewhere in the brain. So if you treat someone with Parkinson's using high and/or prolonged doses of L-DOPA, do you increase their risk of a psychosis? Yes. If you treat someone with schizophrenia using high and/or prolonged doses of a dopamine receptor blockers, do you increase their risk of a Parkinsonian movement disorder? Yes—it's called "tardive dyskinesia," and its symptoms are referred to in a slangy way as the "Thorazine shuffle." (The Southern rock band Gov't Mule even has a song about it called "Thorazine Shuffle," whose final lyrics are "Ain't no need to worry today, Thorazine shuffle make everything OK." Not quite, but it's a good, Allman Brothers–esque song, and it's nice to see popular music less antiquated than "Lucy in the Sky with Diamonds" teaching about neurochemistry.)
30. Many psychoanalysts approved of mothers being tarred with schizophrenogenic mothering, not just because they thought it was correct but also because the guilt made mothers more prompt in paying the shrink in a timely manner. Some did advocate, however, that these guilt-riddled parents be treated with some humaneness, but most seemed to view this as sentimentality.
31. Eleanor DeVito Owen was extraordinary. Over the course of her lifetime, she was a journalist, playwright, professor, costume designer, successful actress, and immensely successful mental health advocate. And our

conversation was delayed for a stretch while she traveled across the country alone to visit her nonagenarian kid sister. She died in early 2022, a few weeks after the publication of her memoir, *The Gone Room*, on her 101st birthday. In our conversation, she was vibrant, passionate about the political past and present, and self-effacing about her role in righting one of the travesties of psychiatry's past. If my belief system were a very different one, I would say that I was blessed by having gotten to briefly be in her orbit.

32. I had the pleasure and privilege to have long conversations with Flynn and Honberg as well. Now in their later years, as they reflected back on the uphill battle that they had waged, one gets the sense of what lives well lived look like.
33. Yeah, in case you can't tell, I admire Torrey immensely and consider him an inspiration; he's also a very kind, decent man.
34. One can be jaundiced and/or grateful when a politician with a track record of little sympathy for underdogs selectively develops some for a particular topic that they are personally touched by. Just to take that jaundice to the next level, many a scientist says, in effect, "Oh, please, please, let the loved one of some Republican senator come down with the awful disease I study so there'll finally be enough funding for us to figure out how to cure it."
35. When I was being recruited to Stanford in the mid-1980s, people bragged about the quality of biological psychiatry in the Bay Area—Stanford had already purged the psychoanalysts from leadership positions in its psychiatry department, and UCSF was in the process of doing the same. It was definitely a draw.
36. The vanquishing of the idea of schizophrenogenic mothering might appear to have a substantial problem. As it was formulated, schizophrenogenic mothers (or fathers or family members) drove their loved one into late-adolescent schizophrenia through the toxic ways that they interacted with them. But then the discovery of things like elevated dopamine levels, impoverished frontal cortical circuitry, and ventricular enlargement screamed that this is a biological disease. In other words, experience (such as the adversity of that style of mothering) can't be the cause of the disease if the disease involves structural and chemical changes in the brain. But experience does exactly that to the brain; just go back to some of the examples from chapters 3 and 4—childhood poverty thins the frontal cortex; chronic stress shrinks the hippocampus and enlarges the amygdala.

So why can't it be the case that schizophrenogenic mothering causes schizophrenia *by way of* elevating dopamine levels, atrophying the cortex, and so on? That would seem like a sophisticated, contemporary view of biology and environment interacting. Uh-oh, have we just reinvigorated schizophrenogenic mothering? Not at all. There's no science to show that the mothering style could produce those brain changes. Experts couldn't even reach consensus as to what the style consisted of. No one could demonstrate that supposedly schizophrenogenic mothers mothered dramatically differently when it came to their nonschizophrenic children. Neurological and neuropsychological markers of the disease are apparent as early in life as they can be studied. And oh, there are those genes involved. Schizophrenogenic mothering is dead ideology.

37. The Joan of Arc of climate change, Greta Thunberg, is one such individual; she credits her Asperger's syndrome with sparing her from social distractions, allowing her to focus on saving the planet.
38. Bettelheim had another domain of fraudulent, self-aggrandizing blaming that evokes particular revulsion in me, in that he was a classic anti-Semitic Semite, blaming his fellow Jews for the Holocaust. Addressing a group of Jewish students, he asked, "Anti-Semitism, whose fault is it?" and then shouted, "Yours! . . . Because you don't assimilate, it is your fault." He was one of the architects of the sick accusation that Jews were complicit in their genocide by being passive "sheep being led to the ovens" (ever hear of, say, the Warsaw Uprising, "Dr." Brutalheim?). He invented a history for himself as having been sent to the camps because of his heroic underground resistance actions, whereas he was actually led away as meekly or otherwise as those he charged. I have to try to go through the same thinking process that this whole book is about to arrive at any feelings about Bettelheim other than that he was a sick, sadistic fuck. (The quote comes from R. Pollack, *The Creation of Dr. B: A Biography of Bruno Bettelheim*, London, UK: Touchstone [1998], page 228.)

## Chapter 14: The Joy of Punishment

1. In my writing and lectures, I try to refer to, for example, lepers, schizophrenics, or epileptics instead as, "people with" leprosy, schizophrenia, or epilepsy. It is a reminder both that there are actual humans involved in these maladies and that such people are not merely

their disease. I'm dropping that convention in this section, reflecting the nature of this historical event—for the promulgators of this savagery, their actions did not concern “people with leprosy.” They concerned “the lepers.”

2. Supposedly because Jews, unlike Christians, didn't have sex during menstruation, one of the supposed causes of leprosy.
3. Mind you, no actual wells were ever poisoned.
4. This is an example that I covered at greater length in my book *Behave: The Biology of Humans at Our Best and Worst*.
5. By the way, Weyer's book was condemned by both Catholics and Protestants.
6. Louis, apparently chastened by his brush with mortality, vowed to pay more attention to the affairs of state and to cavort less with mistresses; the latter resolution apparently lasted a few weeks.
7. Who included Giacomo Casanova—you know, *the Casanova*—who had rented an apartment with fellow partying friends (and who described a sexual act with one of the women there while she was leaning out the window to get a good view of the goings-on).
8. As one measure of Nelson Mandela's status as a moral giant, he insisted that the commission also investigate human rights violations by African National Congress fighters (i.e., his “side”).
9. Why “bias”? Mallon, an Irish immigrant at a time when her people occupied the lowest rung of New York's ethnic hierarchy, probably would not have been treated that way if her last name had been, say, Forbes or Sedgwick; as evidence, during the remainder of her lifetime, more than four hundred other asymptomatic spreaders were identified, with none forcibly quarantined in the same way. Actually, the bias had an additional motivation—Mallon's transgressions included not only being Pestilential While Irish, not only sickening her fellow tenement dwellers, but also sickening the wealthy families whom she served as a cook. She was released from the island in 1910 and returned to working as a cook under an assumed name, again spreading the disease; apprehended in 1915, she unwillingly lived out her days on the island for roughly twenty-five years. That business about using a fake name kind of besmirches the picture of



her as blameless victim; on the other hand, her only other possible work was as a laundress, where her wage would have been half the starvation-level wage she received as a cook.

10. Caruso frames this as “incapacitating” the person with the “least infringement.”
11. This raises an issue that really gets me into the weeds: If we’ve gotten to a point of recognizing that it is not right for anyone to be blamed or punished for something negative that they do, is it okay to not want to be around someone yearning for social contact because circumstance made them irritating, boring, irksome, chew with their mouth open, derail conversations with inane puns, whistle tunelessly in a crazy-making way, etc.? Are we teetering on the edge of the equivalent of convincing your child that *everyone* in their kindergarten class should be invited to their birthday party, including even the kid they don’t like?
12. As some sort of cosmic joke, spell-check keeps turning *funishment* into *punishment*. Also, when you Google *funishment*, you get sent not only to various philosophical debates but also to BDSM sites, plus some beer maker whose product is supposedly ideal for someone who is a glutton for funishment.
13. A comparison between Norway and the U.S. is obviously complicated by apples versus oranges, because the government of someplace like Norway already perceives moral obligations to take care of its citizens to an extent that Americans currently can only dream of.
14. An instructive lesson came from a couple honeymooning on a small resort island in the Maldives when the pandemic hit; because of the timing of different countries shutting down air travel, they were stranded there for months, the lone guests, along with the resort staff, also marooned there. A dozen otherwise bored waiters scrambled to fill their water glasses after each sip, their pillows were fluffed up by room staff hourly. Basically, it sounded like hell with a private cabana. “Everyone says they want to be stuck on a tropical island, until you’re actually stuck. It only sounds good because you know you can leave,” said one of the tanned captives.
15. His year of birth is unclear.
16. Five African American lawyers attempted to appeal Bethea’s conviction on grounds of incompetent legal representation. They were told that, sorry, the

appeals court was closed for the summer; by the time fall rolled around, Bethea was long dead.

17. The executioner arrived too drunk to spring the trap; a deputy sheriff stepped in.
18. Controversy on the national stage notwithstanding, Thompson was acclaimed in Owensboro. When she ran for reelection, she received all but 3 of the 9,814 votes cast.
19. Numerous reporters from the North covered the event, drawn by the chance to see Thompson spring the trap; robbed of that, they instead filed stories about Southern barbarity. Embarrassed, the Kentucky legislature soon banned public hangings.

The notoriety weighed on Owensboro for decades, and the town developed a bristly, self-serving revisionism in which the twenty thousand attendees fighting for good spots and souvenir cloth were entirely outsiders, and that the town itself had shunned the spectacle.

I can't resist noting that Owensboro's most celebrated native son is Johnny Depp. Make of that what you will.

20. Opening doors for people of color from one of the other hellholes on earth? Well, not so much. I suppose in that case, our striking human sociality is shown when nationalists cooperate in forming political parties charging that immigrants are destroying European culture.
21. Long biology digression: Mitochondria, seventh-grade biology's "powerhouses of the cell," are at the center of one of the coolest events in the history of life. Mitochondria were once tiny, independent cells, with their own genes, willing to attack larger cells for their own benefit; those larger cells would counterattack with proteins that would perforate mitochondria, or by engulfing mitochondria and harvesting their molecules. Then, in the "endosymbiotic" revolution some 1.5 billion years ago, swords were hammered into plowshares, and when a large cell engulfed a mitochondrion, rather than destroy it, it allowed the mitochondrion to live there, to their mutual benefit. Mitochondria had evolved the capacity to use oxygen to generate energy, a hugely efficient move; they shared the plentiful fruits of their oxygen-based metabolism with the enveloping cell, which in turn protected mitochondria from the wear and tear of the outside world. And in a move reminiscent of two

medieval rulers making a peace treaty but, not trusting each other, sending their sons to be guests/spies/prisoners in the other kingdom, mitochondria and the host cells even traded some of their own original genes (although it was overwhelmingly mitochondria transferring genes to the host cell).

Where does cheating come in? When it's time for the cell to divide, you have to make new copies of everything, including the DNA in the nucleus, mitochondria, and so on. And some mitochondria will cheat, making way more new copies of themselves than they're "supposed to," dominating replicative resources for themselves. The cells' countermeasure? We'll get to that.

How about DNA cheating? The entire genome is a cooperative venture, individual genes and other DNA elements working collectively when replicating. It turns out that there are stretches of DNA called transposons that code for nothing useful and are usually derived from ancient viruses. And they are selfish, insofar as all they care about is making more copies of their useless selves, trying to monopolize the replication machinery. As a measure of the effectiveness of their cheating, about half of human DNA is derived from self-serving copies of useless transposons. And the cell's response to that selfishness? We'll get to that as well.

As a reminder, lionesses, fish, bats, bacteria, mitochondria, and transposons are not consciously plotting about how to cheat for their own benefit. This personifying language is just shorthand for things like "Over the course of time, transposons that evolved the capacity for preferential self-replication became more prevalent."

22. What do unfettered exploitation, restrained exploitation, and punishment look like in the Ultimatum Game? There are two players. The first player gets \$100 and then divides it between the two of them however the first player pleases. Offering zero and keeping \$100 is maximal exploitation. Fifty-fifty maximizes fairness. Most people start off somewhere around a restrained sixty-forty. Where does punishment come in? The only power that the second player has is to refuse the offer—in which case, neither gets anything.
23. The folks who are *really* prosocial are the ones who readily do third-party punishment without bothering to do self-serving second-party punishing.
24. The temporal-parietal junction.

25. There's an additional kind of punishment that is really messed up. Termed "perverse" or "antisocial" punishment, this is when someone is punished for making *too* generous of an offer; it is motivated by how unpunished generosity will make the rest of us look bad, pressuring everyone else to start being generous. Cross-cultural studies show that you find this malignant kind of punishment only in cultures that you wouldn't want to live in—those with low social capital, with low levels of trust and cooperation.
26. In traditional Fijian culture, being a third-party punisher of antisocial behavior isn't costly—it is understood that you can do things like steal possessions of the miscreant with impunity.
27. For example, a selection of the many books currently available on Amazon: *The Ultimate Serial Killer Trivia Book* (Jack Rosewood, 2022); *True Crime Activity Book for Adults* (making one wonder what the kids' edition looks like; Brian Berry, 2021); and of course, *Serial Killers Coloring Book with Facts and Their Last Words* (Katys Corner, 2022).
28. Whether humans or rhesus monkeys; in a paper entitled "Monkeys Pay per View: Adaptive Valuation of Social Images by Rhesus Macaques," male rhesus monkeys were shown to be willing to "pay" the price of forgoing desirable juice in order to see, well, crotch shots of female monkeys. Meanwhile, female rhesus monkeys liked looking at pictures of high-ranking males (which, given the characteristic aggressiveness of male rhesus, is a bit like falling for the animal magnetism of Billy Bigelow) or crotch shots of both male and female rhesus. Okay, just to go further down the rabbit hole, when female rhesus are ovulating, they show a stronger preference for looking at the faces of male rhesus (but, in an oddly reassuring way, not the faces of male chimps or humans).
29. I'm not remotely going to try to summarize what happened at either, as they will be mired in controversy forever; both have taken on near-sacred significance to the antigovernment militia movement.
30. The process begins with the seemingly bizarre step of cleaning the infusion site with alcohol. What, so the person won't get an infection after they're dead? Why not also try to sell them a new coffee maker, to be delivered within three to five working days? In actuality, the alcohol makes it easier to find a vein.
31. In *Discipline and Punish* (which begins with the execution of Damians),

Michel Foucault rejected this sanguine idea; instead, he framed this as part of the shift from the state asserting power by owning and breaking a person's body—execution—to asserting it by owning and breaking their spirit and soul long before that, thanks to years of moldering imprisonment and the ceaseless surveillance of the panopticon. Political theorist C. Fred Alford of the University of Maryland rejects this interpretation. He lost me, though, when he started discussing what he called the microphysics of power (I was pretty lost with Foucault as well, actually).

32. Linders speculates that the decision was made to include the press as witnesses precisely for this reason.
33. In the words of legal scholar Pete Alces, the challenge of the death penalty is that it can feel intensely like both too much and too little, often for the same person (personal communication).
34. It's important, however, to point out the obvious factor that Texas and Minnesota differ from each other in lots of other dramatic ways, so these findings are merely correlative.
35. It is important to note that, despite the time-limited fufishment, Breivik has spent much of his time in solitary, because of the danger of his interacting with other prisoners, and his twenty-one-year sentence can be extended if he is deemed to still be a danger to society. At one point, he sued the Norwegian government over the cruel nature of his isolation (he was ultimately unsuccessful). In searching for a solution, a psychiatrist working for the prison suggested that retired police officers visit Breivik to socialize, drink coffee, and play card games.
36. Breivik had bought the uniform and tchotchkes from military surplus dealers and sewed on the medals; it's unclear if he knew what they signified, but he had awarded himself medals for, among other things, valor in the U.S. Navy, Air Force, and Coast Guard.
37. And of course, as with all these examples, none of these were monolithic group responses. "You are Satan. Instead of a heart, you have a cold, dark space," said the daughter of another victim, hoping that the shooter would "go straight to hell."
38. Just imagine the implausibility of the same if circumstances were such that Osama bin Laden were living out his days in a supermax prison.

39. To my vast relief, the case never went to trial—there was a guilty plea for life without parole rather than the death penalty.

## Chapter 15: If You Die Poor

1. The famous quote might actually be apocryphal; see [quoteinvestigator.com/2011/02/09/darwinism-hope-pray/](http://quoteinvestigator.com/2011/02/09/darwinism-hope-pray/).
2. A philosophical stance called illusionism, associated with philosopher Saul Smilansky, whose ideas were discussed in the previous chapter.
3. Right around now, I'm concerned about my prattling on about "truth," rejecting so many other people's thinking about free will, worried that I'm going to come off as self-congratulatory. That I *am* self-congratulatory. Wow, all these super-smart people who run philosophical circles around me, and I'm one of the few who understand that you can't successfully wish for what you want to wish for or will yourself to have willpower. Wow, I'm awesome. The previous few paragraphs suggest an additional route to being self-congratulatory—wow, all these thinkers fleeing from unpalatable truths to the point of irrationality, and I'm the one with the bollocks to lick truth's smelly armpit.

This many pages into this book, I hope it's clear that I don't think it is valid for anyone to be self-congratulatory about anything. At some point in this writing process, I was struck with what seemed like the explanation for why I've been able to stick with an unshakable rejection of free will, despite the bummers of feelings it can evoke. A point made earlier in the chapter is personally very relevant. Since my teenage years, I've struggled with depression. Now and then, the meds work great and I'm completely free of it, and life seems like hiking above the tree line on a spectacular - snow-capped mountain. This most reliably occurs when I'm actually doing that with my wife and children. Most of the time, though, the depression is just beneath the surface, kept at bay by a toxic combination of ambition and insecurity, manipulative shit, and a willingness to ignore who and what matter. And sometimes it incapacitates me, where I mistake every seated person as being in a wheelchair and every child I glance at as having Down syndrome.

And I think that the depressions explain a lot. Bummed out by the scientific

evidence that there's no free will? Try looking at your children, your perfect, beautiful children, playing and laughing, and somehow this seems *so* sad that your chest constricts enough to make you whimper for an instant. After that, dealing with the fact that our microtubules don't set us free is a piece of cake.

4. At the 2018 Harvard graduation, the poised, articulate student chosen to give a speech, Jin Park, showed that he understood turtles. Why was he there in that celebration of talents and accomplishments? Because, he explained, day after day, his undocumented immigrant father worked as a line cook in restaurants (that probably exploited the hell out of him, since he lacked papers), because his undocumented immigrant mother toiled endlessly, giving pedicures in beauty salons. "My talents are indistinguishable from their labors; they are one and the same."
5. And even phrased this way, this is a false dichotomy, making a distinction between the benighted few who can ignore all this and remain convinced that they deserve their superyacht and the unwashed majority who need to be convinced that it's not their fault that they don't own one. Every page really applies to all of us, because we are all destined at times to blame, be blamed, hate, be hated, feel entitled, and suffer the entitled.
6. I'm making reference in the title to this section to the great intellectual hoax known as the Sokal affair. Physicist Alan Sokal of NYU and University College London got fed up with the intellectual emptiness, agitprop, and toeing of party line in a lot of postmodernist thinking. He thus wrote a paper that (a) agreed that physics and math are guilty of the sins of various antiprogressive -isms; (b) confessed that the supposed "truths" of science, as well as the supposed existence of "physical reality," are mere social constructs; (c) fawningly cited leading postmodernists; and (d) was packed with science gibberish. It was submitted to and duly published in 1996 by *Social Text*, a leading postmodernist cultural studies journal, as "Transgressing the Boundaries: Toward a Transformative Hermeneutics of Quantum Gravity." The hoax was then revealed. Massive brouhaha, conferences of postmodernists condemning his "bad faith," Jacques Derrida calling him "sad," and so on. I thought the paper was glorious, a hilarious parody of postmodernist cant (e.g., "the content of any science is profoundly constrained by the language within which its discourses are formulated; and mainstream Western physical science has, since Galileo, been formulated in the language of mathematics. But *whose* mathematics?"). With tongue firmly in cheek, Sokal proclaimed the paper's goal to be fostering a "liberatory science" that would be freed from

the tyranny of “absolute truth” and “objective reality.” Thus, in the present case, I’m noting “without tongue in cheek,” because I’m going to argue that science dumping the concept of free will is truly liberating.

(The Sokal affair was seized upon by the likes of Rush Limbaugh as an exposé of the Left’s intellectual fraudulence, with Sokal embraced as some sort of right-wing scourge. This infuriated me, as Sokal had walked the walk as a leftist—for example, in the 1980s, he left his cushy academic post to teach math in Nicaragua during the Sandinista revolution. Furthermore, anything the Right had to say about truth ended with “alternative facts” in Trump’s first week in office. As an aside, in college, Sokal lived down the hall, two years ahead of me and thus too intimidating of a big kid to talk to; his brilliance, wonderful eccentricity, and willingness to call BS were already legendary.)

7. Nitpicky aside: Why say “too little leptin signaling” rather than just “too little leptin”? *Signaling* is a broader term, reflecting that a problem can be at the level of the amount of a messenger (e.g., a hormone or neurotransmitter) or with the sensitivity of cells to the messenger (e.g., abnormal levels/function of receptors for the messenger). Sometimes the radio station is screwed up, sometimes it’s the radio in your kitchen. (Do people still have radios?)
8. An extraordinary, famed example is the Dutch Hunger Winter, when the occupying Nazis cut off the food supply in the Netherlands in the winter of 1944–45, and twenty to forty thousand Dutch starved to death. If you were a fetus then, with you and your mother severely deprived of nutrients and calories, epigenetic changes produced a lifelong thrifty metabolism, a body voraciously adept at storing calories. Be one of those fetuses, and sixty years later, you had a dramatically increased risk of obesity, metabolic syndrome, diabetes, and, as we’ve seen, schizophrenia.
9. And the world of processed foods involves scientists trying to achieve that state with whatever food their boss sells.
10. Really, for the same BMI? Of course. More self-loathing, more secretion of stress hormones resulting in more preferential storage of fat in the gut (among other downsides), more of an increase in metabolic and cardiovascular disease risk.
11. Then there’s the ghastly [quora.com/Is-it-my-fault-my-husband-hits-me](https://www.quora.com/Is-it-my-fault-my-husband-hits-me).



12. James doesn't see the same among higher-SES African Americans or among Whites at all.
13. The words for "Mayn Rue-Plats" were in Yiddish, at a time when it was the language of socialist firebrands on the Lower East Side of New York rather than ultraorthodox ayatollahs. Rosenfeld wrote it in response to the Triangle Shirtwaist Factory fire in March 1911, in which 146 sweatshop workers—almost all immigrants, almost all women, some as young as fourteen—died because the owners had locked an exit, believing that otherwise, workers would sneak out the back way with stolen clothes. A jury found the owners liable for wrongful death, forcing them to pay all of seventy-five dollars compensation to each family of the dead, while the owners themselves received more than sixty thousand dollars for the loss of their factory. Seventeen months later, one of them was found to have once again locked the exits in his new factory and was levied the minimum fine of twenty dollars. One hundred two years later, the Rana Plaza building in Dhaka, Bangladesh, collapsed, killing 1,134 sweatshop workers inside. Cracks had been discovered in the building the day before, resulting in its evacuation; the owners informed workers that anyone not back on the job the next day would be docked a month's pay.
14. Translation by Daniel Kahn.
15. I have been made aware that this bears some resemblance to the Buddhist concept of "unselfing." I have absolutely nothing useful to say about Buddhism beyond that.
16. As of 2022, eighty-five years in Japan, fifty-five in the Central African Republic.

## Appendix

1. Which, among other things, is why the nervous system is so vulnerable to injury. Someone has a cardiac arrest. Their heart stops for a few minutes before it is shocked into beating again, and during those few minutes, the entire body is deprived of blood, oxygen, and glucose. And at the end of those few minutes of "hypoxia-ischemia," every cell in the body is miserable and queasy. Yet it is preferentially brain cells (and a consistent subset of them) that are now destined to die over the next few days.

2. For chemists: in other words, so that the distribution of charged ions inside and out balance each other.
3. Jargon: that little bit of “depolarization.”
4. Ironic footnote: Cajal was the chief exponent of the neuron doctrine. And the leading voice in favor of synctitiums? Golgi; the technique he invented showed that he was wrong. He apparently moped the entire way to Stockholm to receive his Nobel Prize in 1906—shared with Cajal. The two loathed each other, didn’t even speak. In his Nobel address, Cajal managed to muster the good manners to praise Golgi. Golgi, in his, attacked Cajal and the neuron doctrine; dickhead.
5. More with the keys in locks—the reuptake pumps have a shape that is complementary to the shape of the neurotransmitter, so that the latter is the only thing taken back up into the axon terminal.
6. What that also implies is that if a neuron is receiving axonal projections to five thousand of its spines from a neurotransmitter A–releasing neuron and five thousand from a neurotransmitter B–releasing one, it expresses different receptors on those two populations of its spines.
7. Whoa, does that mean that you can regulate the amounts of neurotransmitters with your diet? People got very excited about this possibility in my student days. For the most part, though, this has been a bust—for example, if you were so deprived of proteins that contain tyrosine that you can’t make enough dopamine, you’d already be dead for lots of reasons.
8. So, if SSRIs boost serotonin signaling and lessen symptoms of depression, the cause of depression must be too little serotonin. Well, maybe not. (A) A paucity of serotonin may be the cause of only some subtypes of depression—SSRIs most certainly don’t help everyone and to varying extents; (B) for other subtypes, serotonin shortage may be one of the contributing causes, or even completely irrelevant; (C) just because more serotonin signaling equals less depression, that doesn’t necessarily mean that the initial problem was too little serotonin—after all, just because duct tape can cure a leaking pipe doesn’t mean that the leak was initially caused by a shortage of duct tape; (D) despite the “selective” part of the SSRI acronym, the drugs are actually not perfectly selective and effect other neurotransmitters as well, meaning that these others may be relevant rather

than serotonin; (E) despite what SSRIs do to serotonin signaling, it is possible that the problem is too *much* serotonin—this can arise through a scenario that is so multilayered that it leaves my students gasping for air; (F) even more stuff. As such, a controversy is now raging as to whether the “serotonin hypothesis” (i.e., that depression is caused by too little serotonin) has been oversold. Which seems likely.

9. And this makes sense only after introducing an additional fact. Thanks to random, probabilistic hiccups with the ion channels now and then neurons will occasionally have a random, spontaneous action potential from out of nowhere (which is looked at in depth in chapter 10 when considering what quantum indeterminacy has to do with brain function [*psst*—not much]). So neuron A intentionally fires off ten action potentials, followed soon after by two random ones. That might make it hard to tell if neuron A meant to yell ten, eleven, or twelve times. By calibrating the circuit so that the inhibitory feedback signal shows up right after the tenth action potential, the two random ones afterward are prevented, and it is easier to tell what neuron A meant. The signal has been sharpened by damping the noise.
10. Thanks to the wisdom of Dale, we know that the same neurotransmitter(s) is coming out of every axon terminal of neuron C. In other words, the same neurotransmitter can be excitatory at some synapses and inhibitory at others. This is determined by what type of ion channel the receptor is coupled to in the dendritic spine.
11. Similar circuitry is also seen in the olfactory system, which has always puzzled me. What’s just lateral to the smell of an orange? The smell of a tangerine?